

A COMPARATIVE STUDY OF A STEAM SURFACE
CONDENSER COMPUTER MODEL TO FIELD
TEST DATA

Vincent J. Lynch

NAVAL POSTGRADUATE SCHOOL

Monterey, California



THESIS

A COMPARATIVE STUDY OF A STEAM SURFACE
CONDENSER COMPUTER MODEL TO FIELD
TEST DATA

by

Vincent J. Lynch

December 1979

Thesis Advisors:

Paul J. Marto
Robert H. Nunn

Approved for public release; distribution unlimited

T19136

REPORT DOCUMENTATION PAGE		READ INSTRUCTIONS BEFORE COMPLETING FORM
1. REPORT NUMBER	2. GOVT ACCESSION NO.	3. RECIPIENT'S CATALOG NUMBER
4. TITLE (and Subtitle) A Comparative Study of a Steam Surface Condenser Computer Model to Field Test Data		5. TYPE OF REPORT & PERIOD COVERED Master's Thesis; December 1979
7. AUTHOR(s) Vincent J. Lynch		6. PERFORMING ORG. REPORT NUMBER
9. PERFORMING ORGANIZATION NAME AND ADDRESS Naval Postgraduate School Monterey, California 93940		8. CONTRACT OR GRANT NUMBER(s)
11. CONTROLLING OFFICE NAME AND ADDRESS Naval Postgraduate School Monterey, California 93940		10. PROGRAM ELEMENT, PROJECT, TASK AREA & WORK UNIT NUMBERS
14. MONITORING AGENCY NAME & ADDRESS (if different from Controlling Office) Naval Postgraduate School Monterey, California 93940		12. REPORT DATE December 1979
		13. NUMBER OF PAGES 67 pages
		15. SECURITY CLASS. (of this report) Unclassified
		15a. DECLASSIFICATION/DOWNGRADING SCHEDULE
16. DISTRIBUTION STATEMENT (of this Report) Approved for public release; distribution unlimited		
17. DISTRIBUTION STATEMENT (of the abstract entered in Block 20, if different from Report)		
18. SUPPLEMENTARY NOTES		
19. KEY WORDS (Continue on reverse side if necessary and identify by block number) Marine condenser design, condensers, computerized condenser design.		
20. ABSTRACT (Continue on reverse side if necessary and identify by block number) A comparison between a computer model of a steam surface condenser and data from a machinery test of a DDG-37 class engineering plant is provided. Using ORCON1, a computer code developed by the Oak Ridge National Laboratory, a comparison between a computer model and actual data was made in an attempt to verify the code. The sensitivities of ORCON1 to changes in inputs were explored to determine the effect of inaccuracies in the data. Results show that, especially at lower steaming rates, ORCON1 provides a fair		

20. (Cont'd)

model of the condenser.

A change was made to ORCON1 to account for vapor velocity effects in the condenser. This change improved the correlations between the code's output and the data. Other changes to the code are proposed.

Continuing attempts to verify ORCON1 and further study in improving the code are recommended.

Approved for public release; distribution unlimited

A COMPARATIVE STUDY OF A STEAM SURFACE CONDENSER
COMPUTER MODEL TO FIELD TEST DATA

by

Vincent J. Lynch
Lieutenant, United States Navy
B.S., United States Naval Academy, 1972

Submitted in partial fulfillment of the
requirements for the degree of

MASTER OF SCIENCE IN ENGINEERING SCIENCE

from the

NAVAL POSTGRADUATE SCHOOL
December 1979

ABSTRACT

A comparison between a computer model of a steam surface condenser and data from a machinery test of a DDG-37 class engineering plant is provided. Using ORCON1, a computer code developed by the Oak Ridge National Laboratory, a comparison between a computer model and actual data was made in an attempt to verify the code. The sensitivities of ORCON1 to changes in inputs were explored to determine the effect of inaccuracies in the data. Results show that, especially at lower steaming rates, ORCON1 provides a fair model of the condenser.

A change was made to ORCON1 to account for vapor velocity effects in the condenser. This change improved the correlations between the code's output and the data. Other changes to the code are proposed.

Continued attempts to verify ORCON1 and further study in improving the code are recommended.

TABLE OF CONTENTS

I.	INTRODUCTION-----	10
	A. OBJECTIVES-----	10
	B. SHORT HISTORY OF CONDENSERS-----	10
	C. NAVAL CONDENSERS-----	11
	D. BASIC DESCRIPTION OF ORCON1-----	13
II.	ORCON1-----	14
	A. GENERAL OPERATION-----	14
	1. Condenser Model-----	14
	2. Program Operation-----	15
	a. Subroutine MAIN-----	15
	b. Subroutine INPUT-----	15
	c. Subroutine SECAL-----	15
	d. Subroutine COOLEX-----	15
	e. Subroutine ADJUST-----	15
	f. Subroutine HETTRN-----	16
	g. Subroutine OUTP1-----	16
	B. INPUTS-----	17
	1. Program Control Inputs-----	17
	a. INSTM-----	17
	b. ITRAN-----	17
	c. OUTPUT-----	17
	d. IFLOAT-----	18
	e. EXITFR-----	18
	2. Condenser-Related Inputs-----	18
	a. General-----	18
	b. HFCDFL-----	18
	c. BAFFLE-----	18
	d. FDAVE-----	19
	e. FOUL-----	19
	f. ENHI and ENHO-----	19
	g. ENHF-----	19
	3. Steam-Related Inputs-----	19
	a. WSI-----	19
	b. WNCI-----	19
	c. GAS-----	20
	d. STSAT1-----	20

4.	Coolant-Related Inputs-----	20
a.	WBI-----	20
b.	VELBIP-----	20
c.	CBI-----	20
C.	OUTPUTS-----	20
D.	USE OF ORCON1 AS A DESIGN TOOL-----	22
1.	General-----	22
2.	Design-----	22
3.	Verification-----	23
III.	ORCON1 VERIFICATION-----	25
A.	GENERAL-----	25
B.	PROBLEMS IN VERIFICATION-----	25
1.	General-----	25
2.	Problems with Data-----	26
a.	Tube-Related Problems-----	27
b.	Cooling Water Problems-----	27
c.	Fouling Factor-----	27
d.	Saturation Temperature-----	28
e.	Steam Flow-----	28
f.	Air Flow-----	28
3.	Problems With The Code-----	29
a.	Tube Pitch-----	29
b.	Tube Construction-----	30
c.	Baffles-----	30
d.	Single Pass-----	30
IV.	VERIFICATION OF ORCON1 FOR A SMALL CONDENSER-----	31
A.	GENERAL-----	31
B.	CONDENSER AND DATA DESCRIPTION-----	31
C.	RESULTS OF VERIFICATION-----	33
1.	Numerical Comparison-----	34
2.	Sensitivity of ORCON1-----	35
3.	Summary-----	37
V.	IMPROVEMENT OF ORCON1-----	38
A.	GENERAL-----	38
B.	PRESSURE DROP-----	38
C.	NON-TUBE CONDENSATION-----	39
D.	VAPOR VELOCITY-----	40

VI. CONCLUSIONS AND RECOMMENDATIONS-----	41
BIBLIOGRAPHY-----	66
INITIAL DISTRIBUTION LIST-----	67

LIST OF TABLES

I.	ORCON1 Input and Output for the Example Condenser Design-----	43
II.	ORCON1 Input and Output for the First Iteration of the Example Condenser Design-----	44
III.	ORCON1 Input and Output for the Verification of the Example Condenser-----	45
IV.	Data for Test Runs A.1.1 to A.4.1 for the DDG-37 Class Test Condenser-----	46
V.	ORCON1 Results for Run A.1.2-----	47
VI.	ORCON1 Results for Run A.2.1-----	48
VII.	ORCON1 Results for Run A.4.1-----	49
VIII.	ORCON1 Results for Run A.1.1-----	50
IX.	Comparison of ORCON1 Output and Data for Runs A.1.1 to A.4.1 for Heat Load, LMTD, and Pressure Drop-----	51
X.	Comparison of ORCON1 Output to the Test Data for Runs A.1.1 to A.4.1 for Heat Load, Cooling Water Temperature and Exit Fraction-----	52

LIST OF FIGURES

1.	ORCON1 Condenser Model-----	53
2.	Flow Chart of the ORCON1 Program-----	54
3.	Flow Chart for the Subroutine SECALC-----	55
4.	Dependence of the Heat Transfer Coefficient on the Tube Cleanliness for Run A.2.1-----	56
5.	Dependence of the Exit Fraction on the Tube Cleanliness for Run A.2.1-----	57
6.	Cutaway View of the Main Condenser of the DDG-37 Class Ships-----	58
7.	Effect of the Inlet Steam Temperature on the Heat Transfer Coefficient for Run A.2.1-----	59
8.	Effect of the Inlet Steam Temperature on the Exit Fraction for Run A.2.1-----	60
9.	Relationship Between the Heat Transfer Coefficient and the Non-Condensable Gas Flow for Runs A.2.1 and A.4.11-	61
10.	Relationship Between the Exit Fraction and Non- Condensable Gas Flow for Runs A.2.1 and A.4.1-----	62
11.	Effect of FDAVE on Heat Transfer Coefficient for Runs A.1.1 to A.4.1-----	63
12.	Effect of FDAVE on Exit Fraction for Runs A.1.1 to A.4.1-----	64
13.	Relationship Between Heat Load and Steam Flow Rate for Runs A.1.1 to A.4.1-----	65

I. INTRODUCTION

A. OBJECTIVES

The objectives of this thesis are twofold. First, it is the intention to discuss the use of ORCON1, a computer code developed by the Oak Ridge National Laboratory for use in condenser design. This is done to enable follow-on work to be more easily accomplished. The second purpose of this paper is to attempt to determine if ORCON1 provides an accurate representation of an actual condenser. This will be accomplished by comparing the output of the code to data obtained from an actually existing condenser. A complete discussion of the factors affecting the output and sensitivities of the program will be undertaken with the intention of suggesting possible improvements.

B. SHORT HISTORY OF CONDENSERS

Early steam systems did not have separate condensers. Probably the first recorded plan for the use of a surface condenser was proposed by Jean Hautefeuille in 1678.[1] However, James Watt was the first person to actually build a surface condenser. He did this in 1765, almost 90 years after it was first suggested. Some 77 years later, in 1842, Captain John Ericsson introduced the first surface condenser with a cooling water pump driven by a separate engine. Between 1895 and 1923, many innovations appeared including development of internal air coolers, the provisions of steam lanes in tube

banks, addition of separate condensate and air removal pumps, development of better vacuum pumps, and use of higher water velocity in the condenser tubes.

From this time on, the major changes in condenser design included development of different bundle geometries, better steam distribution, increased use of baffles, use of tube bundle modules, enhanced tubes and different tube materials. In spite of all the development which has taken place, condenser design appears to be still more of an art than a science. The Heat Exchange Institute (HEI) Standards for Steam Surface Condensers, which are widely used as the criteria for design and specification of surface condensers, uses a square root of velocity relationship to determine the overall heat transfer coefficient, U . [2] These standards do not consider effects of changes in steam distribution, vapor velocity, or any number of other important considerations. The entire method is empirical. Using this method, for instance, there is no way to predict how a change in geometry will affect the performance of the condenser.

To alleviate this problem and to provide a design tool, a number of computer codes have been developed. However, most have been produced by companies and are considered proprietary. If more efficient and smaller condensers are to be developed, new and better computer codes must be written.

C. NAVAL CONDENSERS

Steam plants with surface condensers have provided the means of generating electricity and have been the main source of power on naval ships for most of this century. They were

reliable and burned a variety of fuels. Recently, however, steam plants have been replaced by gas turbine engines on two new classes of naval ships, the DD 963 and the FFG 7 classes. Gas turbines offer a number of advantages. For example, preliminary estimates [3] for the DD 963 class ships show that the following advantages should be obtained:

1. Lower life cycle costs than other systems.
2. Low machinery vibration levels resulting in low ship radiated and self noise levels.
3. Thirty percent less manning in engineering departments.
4. Thirty-three percent decrease in weight to horsepower ratio.
5. Smaller machinery space requirements.

In addition, the gas turbine engine allows a much faster start-up and permits more rapid speed changes. In view of the advantages of gas turbines, an attempt to improve condensers may seem like a waste of time. However, there are a number of reasons to continue this work.

1. Steam plants are reliable and relatively simple to maintain. If they could be made more efficient, their size might be reduced, making them more attractive.
2. For use in submarines, nuclear steam plants are required if the submarine is to have submerged speed and endurance. Since it is impractical to carry large quantities of oxygen, all types of combustion engines are eliminated as the prime mover. Increased condenser efficiency is particularly important since size is so limited in a submarine.

3. In order to be more efficient, many gas turbine plants have waste heat recovery systems in which steam is generated by the turbine exhaust gases. Here again, a small condenser is needed.
4. Given the instability of oil production, and since all oil supplies are being rapidly depleted, warships of the future may need to have a nuclear steam system as the source of power. With technology that exists now, nuclear fuel for the foreseeable future can be produced while alternatives for oil may or may not prove practical. In this case, condensers again assume importance.

D. BASIC DESCRIPTION OF ORCON1

ORCON1 is a computer code written for the parametric study of steam condensers.[4] It was created at the Oak Ridge National Laboratory for use in desalinization studies. There are two versions. One version assumes a tube bundle of rectangular cross section. The second is used if the cross section is circular. The program takes various condenser input parameters such as steam flow, cooling water flow, tube size and construction and determines operating characteristics such as log mean temperature difference (LMTD), overall heat transfer coefficient, U , exit steam fraction and heat removed. In the next section, ORCON1 will be discussed in greater detail.

II. ORCON1

A. GENERAL OPERATION

1. Condenser Model

The model used in the circular version of ORCON1 is seen in Figure 1. It is a one-dimensional model of a condenser with a bundle of tubes of circular or semicircular cross section and a central void. For calculation purposes, the bundle is divided into sectors of 30 degrees each. The following assumptions are used in the model:

- a. Cooling water flow is in the tubes and makes only one pass.
- b. The tubes are spaced in an equilateral triangular pattern.
- c. Steam flow is radial, i.e., one dimensional.
- d. Baffle options on the shell side consist of simple radial baffles at 2,4,8, and 10 o'clock.
- e. A central air cooler with steam flow vertically upward is optional. The cooler, when present is rectangular in cross section and initially equal in height to the radius of the condenser. The cooler calculation is independent of the geometry of the condenser.

Although the model is divided into 12 sectors, only six at most are calculated. The others, if used, are based on symmetry considerations. For special shapes, any number of sectors may be calculated.

2. Program Operation

ORCON1 is written in FORTRAN IV and is designed to be used with the IBM 360 computer. The basic program is on cards with the inputs being read in from a deck. For this work, the program was modified so that the CP-CMS system could be used. The program is composed of seven major subroutines--MAIN, ADJUST, COOLEX, HETTRN, INPUT, OUTP1, and SECALC, which are described below.

a. Subroutine MAIN

This subroutine provides the basic control for the entire code. It calls the other subroutines as necessary to obtain a final solution. It also calculates the bundle geometry, tube length factors and inlet steam factors. Figure 2 provides the basic flow chart.

b. Subroutine INPUT

This subroutine is used to enter the input data. As stated before, this is normally done with cards.

c. Subroutine SECALC

SECALC calculates all the parameters for each row including steam flow rates and temperatures. A row in the ORCON1 model is defined as all the tubes located at a constant radial position. Hence, a row is normal to the direction of steam flow.

d. Subroutine COOLEX

This subroutine calculates the cooler parameters.

e. Subroutine ADJUST

ADJUST compares the exit steam fraction to the desired value. If it is outside tolerance, ADJUST changes

either steam condenser inlet flow or the tube length and returns to MAIN.

f. Subroutine HETTRN

HETTRN supplies LMTD and U for a given row of tubes.

g. Subroutine OUTPl

OUTPl provides the output to the printer.

In order to obtain a feel for how the program works, a brief description of the solution process follows. It is not intended to be complete; it is included only so that the rest of the work may be more easily understood. For a complete description, see Ref. 4.

Initially, the MAIN program calls INPUT which enters the data. The inputs will be discussed at length in the next section. Using the number, spacing, and size of tubes in the bundle, the number of rows is calculated. Next, the code finds the number of tubes in a vertical row above the central tube in each row. This is later used to account for tube condensate flooding. In SECALC, the condenser parameters are calculated.

As can be seen in Figure 3, the condenser performance is calculated row by row, sector by sector. SECALC calls HETTRN to determine the overall coefficient of heat transfer for the row of tubes under consideration. Once all sectors have been used, pressure drop across each is compared, inlet steam flow to a sector is altered and the process is repeated until the pressure drop across sectors is equal. When SECALC is completed, COOLEX is called and the cooler parameters are calculated in a manner similar to that for the bundle.

At this point, control passes to ADJUST and one of two things happens: If the exit fraction is within tolerance of that specified, then the output is printed, or if the exit fraction is outside the tolerance, then either the steam flow rate or the tube length is adjusted and control returns to MAIN for another run.

B. INPUTS

At this point the program inputs will be discussed in considerable detail. This will be done while maintaining emphasis on problems related to the use of these inputs. The inputs can be divided into four types. There are program control inputs, condenser-related inputs, steam-related inputs, and coolant-related inputs.

1. Program Control Inputs

a. INSTM

INSTM is used as a flag to control program flow when converging on exit fraction. If INSTM is set at 1, inlet steam is adjusted; if 0, tube length is changed.

b. ITRAN

This input is used as a flag which, when set, causes previous outlet coolant temperatures to be used as input. It is used for multiple pass condensers.

c. OUTPUT

OUTPUT is used to control the amount of output information provided to the user. The output is printed either as a summary or as a summary together with a sector-by-sector listing.

d. IFLOAT

This input is a flag to provide the option of either fixed or floating point display.

e. EXITFR

EXITFR is a target value of exit fraction. Exit fraction is the percentage of inlet steam which is not condensed by the condenser or cooler sections. If EXITFR is set to 0.0, the program will make a single pass and produce output without any adjustment to either tube length or steam flow rate. If set to any other value, it will cause the iteration to occur until convergence is obtained.

2. Condenser Related Inputs

a. General

A number of these inputs are obvious, including the total number of tubes, pitch, diameter of tubes, tube-wall thickness, thermal conductivity of the tube material, and tube length. It should be mentioned, however, that the system of units used for ORCON1 is the English System, so that all inputs must be consistent.

b. HFCDFL

HFCDFL is an input used to indicate symmetry. As stated before, the code actually calculates only a semi-circular tube arrangement. If the condenser of interest is circular, HFCDFL is set to 1 and the program provides the appropriate output.

c. BAFFLE

This input is used as a flag to indicate simple condensate baffles at 2 and 4 o'clock (and at 8 and 10 o'clock if symmetric).

d. FDAVE

In order to correct for condensate rain, a tube spacing parameter, FDAVE, is used. As the vertical drainage from one tube to the next increases, in a side-to-side fashion, FDAVE varies from 0 to 1. A more detailed explanation is given on page 17 of Ref. 4.

e. FOUL

FOUL is the tube fouling factor. It is related to the tube cleanliness which is often specified in the literature by:

$$\text{FOUL} = \frac{1}{U_{\text{dirty}}} - \frac{1}{U_{\text{clean}}}$$

f. ENHI and ENHO

ENHI and ENHO are internal and external tube enhancement factors for heat transfer. For smooth tubes, their values are set at 1.0. If some type of enhanced heat transfer surface were used, the values used would be something greater than 1.0.

g. ENHF

ENHF is a friction factor enhancement for use in the calculation of the pressure drop. It is set to 1.0 for tubes with smooth surfaces.

3. Steam Related Inputs

a. WSI

WSI is the total steam flow rate to the condenser.

b. WNCI

This input provides the total noncondensable gas flow rate.

c. GAS

GAS is used to indicate the type of noncondensable gas in the system. The choices which may be used are air, CO₂, or a mixture.

d. STSAT1

This input is the inlet steam temperature. It is assumed to be the temperature corresponding to the saturation conditions.

4. Coolant-Related Inputs

a. WBI

WBI is the total coolant flow rate to the condenser.

b. VELBIP

This input provides the coolant velocity. Either WBI or VELBIP must be set to 0.0. The code calculates one value based on the other one and the tubing size. For example, if WBI is given a value of 1000, then VELBIP must be set to 0.0, and the program will calculate its value.

c. CBI

CBI is the salinity of the coolant in weight percent.

C. OUTPUTS

Two different options for the output can be selected, either a summary or a summary plus two pages of detailed results for each sector. A sample of a summary output is shown in Table 1.

The program generates the following outputs:

1. The heat transfer surface present for both the cooler and the condenser sections.
2. The inlet and outlet steam velocity.

3. Total heat removed by the system.
4. The pressure drop and the temperature drop of the steam as it moves through the condenser.
5. The condenser size, i.e., the bundle diameter and the inside void diameter.
6. The outlet coolant temperatures for both the cooler and the condenser.
7. The coolant and steam flow rates.
8. The condensate flow from the condenser, the cooler and the total.
9. Two different LMTDs.
 - a. DTCND2, DTCOI2 and DLTOT2 are LMTDs calculated by using the vapor temperature (inlet), average inlet and outlet coolant temperatures for the condenser, the cooler and the total, respectively. This corresponds to the standard method of calculating LMTDs.
 - b. Back-Calculated LMTDs are determined by dividing the total heat removed by a row average heat transfer coefficient and the total area.
10. Two types of heat transfer coefficients are found.
 - a. UPCOND, UPCOOL, and UPAVG are the heat transfer coefficients which correspond to DTCND2, DTCOI2, and DLTOT2, respectively.
 - b. Area Average U is a row by row average of the heat transfer coefficient for the condenser, cooler and the total.

c. Although the area average U and its corresponding LMTD are probably more indicative of actual conditions in the condenser, the rest of this work will deal with only DLTOT2 and UPAVG. This is due to the fact that to compare an area average U to field data is meaningless.

11. Exit Fraction is the percentage of the entering steam which is not condensed by the condenser or cooler.

D. USE OF ORCON1 AS A DESIGN TOOL

1. General

The ORCON1 code can be used in two different ways. It can assist in the actual design of a condenser, or it can help validate an already existing design. These two cases will be explored in greater detail below.

2. Design

The best way to explain how to use ORCON1 to design a condenser is by an illustrative example. For this purpose, it will be assumed that a condenser for a destroyer-size ship needs to be designed. Basic parameters are as given below:

Steam Flow Rate:	217,000 lb/hr
Approximate Number of Tubes:	4000
Size of the Tubes:	5/8" O.D., 18BWG
Tube Material:	90-10 CuNi
Approximate Length:	10 ft

At this point some basic design decisions must be made. Assume a circular cross section is desired with no baffles

present; unenhanced tubes are to be used, with the tube pitch set at 1.33 in both the condenser and the air cooler sections. The cooler is to contain 5% of the total tubes in the unit. Assume also that preliminary study shows that the expected steam temperature entering the condenser is 126°F.

Any number of parameters can be varied and the effect observed. For this case, assume that it is desired to study the effect cooling water velocity has on the condenser, especially in regard to tube size. For the first run, let the cooling water velocity be set at 6.5 ft/sec. Table 1 shows the inputs to the code for this case. As explained before, ORCON1 receives these inputs and iterates SECALC to converge on the required exit fraction, here set to 0.5%. The program obtains convergence by adjusting the tube length since INSTM is set to 0. Table 1 also shows the output for the last iteration and the entire output summary. ALSTI, the final tube length, is 10.768 ft. Now assume that a larger pump is to be used, one which delivers cooling water at 8 ft/sec. Table 2 presents the inputs to and the outputs from ORCON1 for this case. The new tube length is 9.846 feet. The output values can be compared to the previous run to obtain the effect of a velocity change on these quantities, as well as on the tube length.

3. Verification

Since the condensers used in naval applications are generally designed by industry, perhaps the second method of employing ORCON1, i.e., design verification, is even more valuable. Again, the best way to explain this method is with

an example. The final characteristics of the condenser designed in Part 2 will be used as the condenser to be verified. Table 3 shows the input set for the program. Note that exit fraction is set at 0.0. This will cause the code to deliver the output after only a single pass and will prevent steam flow or tube length adjustment. If these inputs deliver an exit fraction of 0.5%, then the condenser is verified. As expected, the exit fraction is 0.5%.

III. ORCON1 VERIFICATION

A. GENERAL

As has been seen, ORCON1 can be a valuable tool for use in condenser design. However, it is just a computer code and still needs to be verified by comparing its output to data from operating condensers. If it can be shown to agree closely with these data, then the code can be used in its present form. If the code does not generate the same results as the data, then the program must be critically evaluated. From this evaluation should come recommendations on methods to modify the code or to discard it completely. It is this verification and evaluation which concerns this section of the work.

B. PROBLEMS IN VERIFICATION

1. General

In order to accurately verify ORCON1, two things must be done. First, condenser data must be obtained for existing condensers. Second, these data must be compared to the program's output when the condenser parameters for that condenser serve as the program input. This should be done for many operating conditions and for many condensers. This is necessary if complete verification is to be obtained. Some of the problems encountered in any attempt to verify the code will not be discussed. The difficulties will be broken into two categories, i.e., problems with the data and problems with the code.

2. Problems with Data

Probably the most difficult task in the verification of ORCON1 is in obtaining suitable data. There are a number of reasons for this. The most important cause of the difficulty is the fact that very little condenser data of any kind exists in the open literature. There is quite a bit concerning single tube condensing units, but little about larger condensers. The reason for this is probably twofold. As stated before, condenser design is a business. The companies which build condensers take data as is necessary for them to build and sell the condensers. Very little sets are published. Also, condensers "always work." They are seldom the critical component in a system. While exhaustive information on flow, pressure drops, mechanical losses, efficiencies, etc., of turbines and reduction gears can be found, few detailed condenser results are available. This appears to be due to the fact that there is much less interest in condensers. This is not to say that no information on condenser performance is available. Seldom, however, are all the data needed for ORCON1 present and even less often do the data have the required accuracy. (In the next section, the accuracy of the inputs will be discussed.)

Probably the best compilation found during this work was a data set created by the Department of Chemical Engineering at Lehigh University. The set contained much information in tabular form, but was lacking any description of the bundle geometry. However, since a list of reference sources was included, it is possible that more information on bundle geometry could be obtained.

The problems encountered in obtaining the individual inputs will now be discussed.

a. Tube Related Problems

Condenser tube arrangement must be either circular or semi-circular in order to be used with this code. Many condensers are circular but others have various shapes. (Note that rectangular bundles can be treated by the other version of ORCON1.) Some condensers contain tube bundles which can't be modeled as either circular or rectangular. Tube materials and dimensions are needed as inputs for the code. Some data sets, which might otherwise be usable for ORCON1 verification, do not contain one of these parameters.

b. Cooling Water Problems

Parameters related to cooling water flow rate or velocity are often missing from data sets. Either coolant flow rate or velocity, as well as inlet and outlet temperatures, are needed for verification. Except for specially instrumented test condensers, coolant flow is seldom measured. In this case, flow must either be estimated from the cooling water pump characteristics or be back calculated from a system heat balance.

c. Fouling Factor

The fouling factor is almost never included in a data set. This is not particularly surprising since it is difficult to obtain. However, it is an important part of the heat transfer characteristics of the system. Figures 4 and 5 show the effects of varying the cleanliness (which is related to the fouling factor) from 80 to 97.5%.

d. Saturation Temperature

As will be seen in the section on sensitivity of the code to changes in inputs, the code is more sensitive to changes in T_{sat} than any other input. The inlet steam saturation temperature is seldom if ever measured. If condenser pressure is given, then the temperature may be obtained, since it generally is a saturated system. However, unless specifically stated, the pressure listed may be that at the inlet of the air ejectors and varies from the inlet pressure by the amount of pressure drop across the condenser. For a pressure drop of 0.4 psia, T_{sat} can change by more than 15 degrees F. This means that T_{sat} at the condenser level can be considerably higher than the stated pressure would indicate. Also, the accuracy of the pressure measurement is often suspect. Generally, the vacuum gages normally installed are not extremely accurate.

e. Steam Flow

The mass rate of flow of steam is required as an input to ORCON1. This parameter is seldom measured directly, although it can be done easily by measuring the pressure drop across an appropriately placed venturi. It can also be determined by weighing the condensate but, for large condensers, this may be difficult.

f. Air Flow

Normally, for operating condensers, air flow rate is seldom reported.

3. Problems with the Code

ORCON1 provides some flexibility in the types of condensers it can model. However, as the model diverges from the actual condenser, the output of the code becomes less accurate. Some of the inherent restrictions of ORCON1 are presented below.

a. Tube Pitch

Tube Pitch, a factor to which the code is very sensitive, is restricted in that only one pitch for the condenser and one for the cooler can be specified. Since, in actuality, operating condensers may have several different sections with different pitches, the program is somewhat limited.

The pitch has a great influence on the pressure drop across the tube bundle. As stated before, the code is very sensitive to changes in steam temperature. Since pressure drop influences the temperature so greatly, pitch has much larger effect than would first be expected.

One possible way to allow the program to handle multiple pitch condensers could be used where the pitch was strictly a function of bundle radius. In this case, the condenser may be thought of as being composed by a series of separate units, each with a different pitch and a large central void. The input, RADFLG, allows a larger central void to be created. Solution of the problem could be accomplished by inputting the pitch of the outermost section and setting RADFLG to create a central void as large as the rest of the condenser. The output of this run would serve as the input data for the next run which would have the pitch of the

second section and the void adjusted to the size of the remaining condenser. This method could be repeated until all sections and the air cooler had been treated.

b. Tube Construction

The code only allows for one type of tube material at a time. Many condensers have two types, often one material for the condenser tubes and another for the cooler tubes. If multiple tube materials were encountered in a single condenser, the code could not handle them directly. If the materials used were a function of radius, a method similar to that described above could be employed. Also, it might be possible to use an average value for thermal conductivity if the tubes were similar.

The tube size is generally constant throughout the condenser. However, if the tube dimensions were to vary, the code could not be used directly.

c. Baffles

As it is presently written, there are effectively two baffle options. Baffles can be simulated at the 2 and 4 o'clock positions or they can be eliminated entirely. Since many other baffle designs actually exist, the program is limited.

d. Single Pass

ORCON1 is designed to be used as a one pass model for the cooling water flow. However, a large number of condensers are two pass, especially those found in submarines. If a two pass condenser were to be studied, it might be reasonable to handle it with ORCON1 in some manner if the tube layout were simple and well documented.

IV. VERIFICATION OF ORCON1 FOR A SMALL CONDENSER

A. GENERAL

This section will present the results of an attempt to validate ORCON1 using data from a relatively small condenser, i.e., under 10,000 square feet of surface area. Included will be a discussion of the sensitivity of the program to small changes in input parameters and also the effects of program modifications.

B. CONDENSER AND DATA DESCRIPTION

1. The condenser used for this verification is one found on some DDG-37 (formerly DLG-6) class naval ships.[5] This condenser has approximately 8,800 square feet of condensing surface, and condenses approximately 270,000 pounds of steam per hour. General arrangement data is given below.

Total Number of Tubes:	5,230
Effective Tube Length:	10' 3.5"
Tube Size:	5/8" O.D. by .049" thick
Tube Material:	90-10 CuNi
Total Area:	8,805 sq. ft.
Pitch:	1.40 in the condenser; 1.30 in the cooler

Complete data can be found in Ref. 5. A sketch of one half of the tube layout is shown in Figure 6.

This condenser is a single pass, surface condenser, similar in size to many found on destroyer size combatants. It is a good condenser for ORCON1 verification for the following reasons.

- a. It is fairly circular in cross section.
- b. No elaborate baffling is used.
- c. There is only one pitch and one tube material used in the condenser and in the cooler.
- d. There is only one bundle.

2. The data used in the verification are found in Ref. 6. The data were obtained during a test conducted to determine the general performance of the DDG-37 class propulsion machinery. The test took place at the Naval Boiler and Turbine Laboratory and was conducted primarily to determine the performance of the turbine and reduction gears. The condenser data were obtained as a byproduct. The various measurements were obtained as described below.

- a. Steam flow measurements were made by weighing the condensate.
- b. Cooling water inlet and outlet temperatures were measured by two thermometers installed in the inlet lines and four in the discharge lines.
- c. Circulating water flow was determined from a heat balance around the condenser, i.e., the total heat load was divided by the circulating water and the temperature rise.
- d. Steam temperature was considered at saturation temperature for the condenser inlet pressure. The

condenser inlet pressure was determined by using the average pressure recorded by eight pressure instruments located eight inches above the condenser inlet flange.

- e. Non-condensable gas flow was measured by a Fischer and Porter 0-20 standard cubic feet per minute inline flowrator.
- f. Pressure at the air ejector suction was measured by a single pressure instrument. This pressure, along with condenser inlet pressure, determines the pressure drop across the tube bundle.

The condenser performance data is shown in Table 4. Only runs A.1.1, A.1.2, A.2.1, and A.4.1 are considered in this work. Some of the testing was done during the winter months which caused inlet cooling water temperatures to be very low. Turbine exhaust pressure was maintained at the design level by throttling cooling water outlet. This resulted in tube velocities which were too low to provide reliable heat transfer data. Therefore, the winter runs are not considered.

C. RESULTS OF VERIFICATION

As stated before, four different cases are considered for this verification. Primarily, the differences in the cases are changes in the steam flow rates. The steam flow rate changes from about 22,000 lb/hr. to 160,000 lb/hr. This represents an equivalent speed change from about 15 to 30 knots, and the range of conditions provides a good test for the code.

The coolant inlet temperatures also vary slightly and the flow velocity ranges from about 4.7 ft/sec to about 8.5 ft/sec.

1. Numerical Comparison

Results for runs A.1.1, A.1.2, A.2.1, and A.4.1 are shown in Tables 5, 6, 7, and 8, respectively. Tables 9 and 10 provide a comparison of computer generated output and data from Ref. 6. All the computer outputs vary from the data in different degrees, but some general observations can be made.

The heat removed as computed by the program is less than that which was found in the data. Coupled with this and partly responsible for it, is the fact that ORCON1 predicts that the exit steam fraction is not 0%, but varies from 8% to 20%. Since the actual test was run under steady state conditions, an exit fraction of this magnitude was obviously not present.

The two different LMTDs calculated by the program both differ from that of Ref. 6. This is not surprising given that the heat removed differs in both cases. In a similar way, the heat transfer coefficients calculated by the code are different from those listed in the data.

The calculated pressure drop across the condenser is always lower than that actually measured. Since all factors are interrelated, it is hard to determine responsibility for the discrepancies. Tables 9 and 10 give the percentage differences between the computer generated solution and the observed data. The deviation in many cases is not alarming. However, as it stands, the differences are of sufficient magnitude to limit the code's usefulness as a design or verification tool.

2. Sensitivity of ORCON1

Comparing the various runs of ORCON1 to each other and to the data allows investigation of the sensitivity of the code to changes in inputs. Before any estimation of what can be done to make the code's output more closely agree with the actual condenser data can be undertaken, the various sensitivities of the program must be examined. Four of the more important inputs in this respect are discussed below.

a. Probably the input to which the program is most sensitive is the input steam temperature. Figures 7 and 8 show the effect that varying the steam temperature has on the heat transfer coefficient, U , and the exit fraction, respectively. As can be seen, as T_{sat} is increased, the exit fraction decreases until it becomes effectively 0. For Run A.2.1, a change in T_{sat} of less than 3 degrees results in a greater than 20% change in the exit fraction. The decrease is almost linear until the exit fraction becomes less than about 0.8%. In a similar way, U varies with T_{sat} . Again, it is linear until it reaches the temperature at which the exit fraction became small. There, U drops sharply. This may be due to the fact that there is little steam to be condensed by the cooler, and hence, little heat is transferred. Since the cooler is about 7% of the total condenser, this brings the overall U down.

b. The cleanliness of the tubes does have some effect on the output of ORCON1. Figures 4 and 5 show the effect of allowing the cleanliness to vary from 80 to 95.5%. The change in heat transfer coefficient is almost linear.

This is to be expected if the basic concept of cleanliness is considered. In Figure 5, the relationship between exit fraction and cleanliness indicates that cleanliness strongly affects the exit fraction. This again is not surprising; however, the magnitude of the effect is greater than might be anticipated. For this case, changing the cleanliness from 85% to 95% changes the exit fraction from about 22% to 14%. This is especially significant since the actual cleanliness is not known, except that it is probably to be found in this range.

c. Another factor which affects the computer output is the amount of air in the condenser. Figures 9 and 10 display what happens in the non-condensable gas flow rate changes from 0 lb/hr to twice that reported in the data. For this range of gas flow, there is no significant change in either U or exit fraction.

d. FDAVE, the tube flooding factor is used to account for the effect of condensate dripping from tube to tube. FDAVE is supposed to be varied from 0 to 1 with decreasing pitch. Figures 11 and 12 show the effect changing FDAVE has on exit fraction and heat transfer coefficient. Ref. 4 indicates that, for the given tube pitch, FDAVE should be on the order of 0.6. However, as is indicated, a value of 1 gives slightly better results. FDAVE was set equal to 1 in all previously discussed runs.

As can be seen from the above discussion, the temperature of the steam is the most important parameter in affecting the computer output. This is true not only in considering the

initial temperature, but also as the steam flows through the condenser. Any factor which affects the temperature change can also have a large effect on the output. A good example of this is the pressure drop which was discussed previously. The code is sensitive to factors other than those listed above; however, those discussed are the most important. This importance is due not only to the program's sensitivity to them, but to the fact that those inputs are, in general, known with the least accuracy.

3. Summary

a. The code provides a fair representation of the condenser studied. It works best when steaming rates are low.

b. There are uncertainties in the inputs which affect the output accuracy. Cleanliness is the input which is known with the least certainty.

V. IMPROVEMENT OF ORCON1

A. GENERAL

As shown in the previous section, output generated by ORCON1 does not agree exactly with data for the case studied. If better correlations are to be obtained, either the code must be modified, or more precise data obtained. This section will discuss ways to improve the code.

B. PRESSURE DROP

As stated before, steam temperature is extremely important and is directly tied to saturation pressure. For this verification T_{sat} was obtained from the pressure just above the inlet flange of the condenser. The code uses this temperature as if it were the temperature of the steam just before it arrives at the first row of tubes. The code does not consider the pressure drop between the inlet flange and the tubes, even though this drop may be significant. A correction could be made to account for this drop. The change would probably be made to MAIN subroutine so that PMIX1 passed to SECALC reflects this pressure drop. Two new inputs would be required; one to indicate the inlet flange size and another to indicate any baffling in this area. Actual data regarding this pressure drop would be helpful, but the change could probably be made using only theoretical principles.

The pressure drop generated by the computer varies significantly from that measured in the data. This may be due in

large part to the problem addressed above. The pressure drop actually measured in the condenser was from the flange to the air ejector inlet. The pressure drop generated by the program was only that found across the bundle itself. If it were assumed that the pressure drop from the inlet flange to the tubes was on the order of .1 psia, the generated pressure drop would agree closely with the data.

C. NON-TUBE CONDENSATION

As stated before, the condenser simulated during these tests was operating at steady state so that a 10% exit fraction is impossible. However, ORCON1 provides the exit fraction generated using only the tubes to condense the steam. In reality, this is not what happens, and some steam is condensed by contact with other parts of the condenser. It is doubtful that this amounts to anything near 10%, but it is something to be considered.

Probably a more important factor in this same area is the steam condensed by subcooled liquid. As the condensate moves toward the hotwell, it contacts steam and condenses some of it. It is difficult to estimate what percentage of the steam is condensed in this manner, but it may be significant.

A simple way to improve the code would be to create a numerical factor based on the percentage of steam not condensed on the tubes. It would range from 0 to 1. This factor would be used to correct the existing value of heat load. By correcting heat load, the value of LMTD would also be changed.

D. VAPOR VELOCITY

One way in which the code can be improved lies in the area of velocity-induced vapor shear. Vapor velocity has the tendency to strip condensate from the tubes which increases the heat transfer coefficient, U , and lowers the exit fraction.

In order to investigate this effect, a correction was made to the HETTRN subroutine to include vapor shear effects. The correction is based on the work by Fujii, Honda, and Oda, as seen in Ref. 7. This correction changes the heat transfer coefficient on the outside of the tubes to reflect the fact that vapor velocity modifies the amount and distribution of the condensate. The change in this heat transfer coefficient causes the overall U to increase. Tables 9 and 10 show the effect this correction has on the ORCON1 output. As expected, the overall heat transfer coefficient calculated by the code increased with the correction. In all cases, U agrees more closely with the data, as does the corrected value of heat load. Figure 13 displays the heat load vs. steam flow for the four runs with and without the vapor velocity correction present. Also plotted is the heat load obtained from the data set. It can be easily seen that the computer results with the vapor velocity correction more closely follow the data at higher flow rates. This is as expected, since as the steam flow rate increases, the vapor velocity increases and the correction has a greater effect.

VI. CONCLUSIONS AND RECOMMENDATIONS

A. ORCON1 can be used as both a design tool and as a means of verifying an existing condenser design. The code can be used for different geometries, but has the limitations previously discussed. These include the inability to be used with odd shaped tube bundles, non-radial baffles, and variations in tube size and pitch.

B. ORCON1 is based on well established heat transfer and fluid flow concepts. However, changes like that made to include vapor velocity considerations can be used to improve the accuracy of the code.

C. Even though ORCON1 is not 100% accurate, it has value in evaluating the effects that design changes have on a condenser. Even though the code may report a heat load which is 10% too low, a feel for the magnitude of variations may be obtained. For example, assume the code is run twice, once with CuNi tubes and once with titanium tubes. Even though both results may be accurate to 10%, an idea of the effect caused by changing the tube material has been obtained.

D. ORCON1 is more sensitive to changes in some inputs than others. The inputs to which the code is most sensitive are:

1. Steam temperature
2. Tube cleanliness
3. FDAVE
4. Non-condensable gas flow rate

E. The following recommendations are made:

1. More work should be done in verification of ORCON1 including the use of different size condensers as the model.
2. Since good data is difficult to obtain, it would be extremely helpful to be able to gather data from a test condenser. If a test condenser were available, it would be beneficial to place the emphasis in data collection on the following parameters:
 - a. Inlet steam temperature
 - b. Steam flow rate
 - c. Cooling water flow rate
 - d. Cleanliness
 - e. Air ejector inlet pressure
3. Measurements should be taken with laboratory type instruments rather than commercial ones, if possible.

Table I. ORCON1 Input and Output for the Example Condenser Design

CASE IDENTIFICATION AND NOTES		TEST CASE	CLEANLINESS	= .9	T	= 126
GEOMETRY SPECIFICATION						
TUBING SPECIFICATION		FLOW AND PROPERTIES SPECIFICATION				
NO. OF TUBES	6000.00	OUTSIDE DIAM., INCHES	0.6250	STEAM FLOW, LBS/HR	217000.	
PCT. TUBES IN COOLER	5.00	WALL THICKNESS, INCHES	0.0490	COOLANT FLOW, LBS/HR.	0.	
LENGTH OF TUBES, FT.	10.00	WALL COND., BTU/HR/SQ.FT./DEG.F.	26.0000	COOLANT VELOCITY, FT/SEC.	6.5	
S/D COOLER	1.330	FLOULING FACTOR	0.0002	STEAM TEMP., DEG. F.	126.00	
BUNDLE RADIUS FACTOR	1.00	TUBE FLOOD FACTOR(FDRAVE)	1.0000	COOLANT TEMP., DEG. F.	75.00	
SECTOR MODEL	4.00	ENHANCEMENT FACTORS	1.0000	WT. FRAC. OF NAEL IN COOLANT	0.03500	
BAFFLE FLAG	0.0	INSIDE FILM	1.0000	EXIT STEAM FRACTION/PCT. OF INPUT	0.5000	
BYM. FLAG	1.00	OUTSIDE FILM	1.0000	NON-CONDENSIBLE FLOW, LB/HR.	6.00	
		FRICTION FACTOR	1.0000			
S ALTD = 10.758 XIFR1 = 0.0057 ALST = 10.768						
SECALC DONE						
8888 STEAM VELOCITY IN FRIST ROW OF COOLER TUBES EXCEEDS MAX ALLOWABLE, VELC(1) = 0.41254E 03						
36 ROWS OF TUBES 9.000 TUBES PER ROW						
COOLER DIMENSIONS ADJUSTED TO LOWER STEAM VELOCITY, VELC(1) = 0.14860E 03						
13ROWS OF TUBES 24.982TUBES PER ROW						
COOLEX DONE						
CONVERGENCE CRITERIA MET FOR EXIT STEAM						
COOLER EXIT STEAM FRAC. 0.0051 ACTUAL TUBES IN CONDENSER 5675.2 ACTUAL TUBES IN COOLER 324.8						
TEST CASE CLEANLINESS = .9 T = 126						
SUMMARY OF RESULTS						
AREA AVERAGE	BACK CALC.	TEMP.	STEAM VELOCITY	TUBE SPACING	TUBE FRACTION	HEAT TRF.
U, BTU/HR/50.FT.	LOG MEAN	PRESSURE	FT/SEC	RATIO,	REMOVED, SURFACE,	MILLION
/DEG. F.	DELTA TEMP,	W/OP	INLET	8/D	BTU/HR	50.FT.
	DEG.F.	LBS/50.IN.	OUTLET	PERCENT		
CONDENSER	545.39	0.2419	77.20	1.330	94.59	209.8957
COOLER	563.08	35.7205	0.0299	1.330	5.41	11.5110
OVERALL	547.29	38.2670	0.3311	6.7158		221.4067
OUTSIDE BUNDLE DIAM., FT. 5.61 INSIDE VOID DIAM., FT. 1.15 NUMBER OF RADIAL TUBE ROWS 37.						
COOLER HEIGHT, FT. 0.83 COOLER WIDTH, FT. 1.78 BUNDLE LENGTH, FT. 10.768						
EXIT STEAM, PERCENT OF INPUT 0.5060 EXIT NON-CONDENSIBLES, PERCENT OF TOTAL EXIT FLOW 0.54						
AVO. URINE TEMPS						
ENTRANCE EXIT						
CONDENSER	74.9994	92.2042	STEAM TO CONDENSER 216999.			
COOLER	74.9998	91.4815	COOLANT TO BUNDLE 13562926.			
OVERALL	74.9994	92.1300	COOLANT VELOCITY 6.5000 F/8			
CONDENSATE FROM CONDENSER 204684.						
CONDENSATE FROM COOLER 11217.						
DTCND2	UPCOND	DTCOL2	UPCOOL	DLTOT2	UPAVO	
41.8099	502.0510	36.5364	556.5078	41.8527	500.4031	

Table II. ORCON1 Input and Output for the First Iteration of the Example Condenser Design

CASE IDENTIFICATION AND NOTES **** TEST CASE CLEANLINESS = .9 T = 124						
GEOMETRY SPECIFICATION						
NO. OF TUBES	4000.00					
LENGTH OF TUBES, FT.	5.00					
S/D OF CONDENSER	1.330					
BUNDLE RADIUS FACTOR	1.330					
SECTOR MODEL	1.00					
BAFFLE FLAG	0.0					
STR. FLAG	1.00					
TUBING SPECIFICATION						
OUTSIDE DIAM., INCHES	0.4350					
WALL THICKNESS, INCHES	0.0470					
FOULING FACTOR	26.0000					
TUBE FLOOD FACTOR(FDAVE)	0.0002					
ENHANCEMENT FACTOR8	1.0000					
INSIDE FILM	1.0000					
OUTSIDE FILM	1.0000					
FRICTION FACTOR	1.0000					
FLOW AND PROPERTIES SPECIFICATION						
STEAM FLOW, LBS/HR	217000.					
COOLANT FLOW, LBS/HR.	0.					
COOLANT VELOCITY, FT/SEC.	8.0					
STEAM TEMP., DEG. F.	124.00					
COOLANT TEMP., DEG. F.	73.00					
WT. FRAC. OF NACL IN COOLANT	0.03500					
EXIT STEAM FRACTION/PCT. OF INPUT	0.3000					
NON-CONDENSIBLE FLOW, LB/HR.	4.00					
8 ALTOLD = 9.841 XTFR1 = 0.0057 ALST = 9.844						
SECALC DONE						
8888 STEAM VELOCITY IN FRIST ROW OF COOLER TUBES EXCEEDS MAX ALLOWABLE, VELC(1) = 0.43861E 03						
36 ROWS OF TUBES 9.000 TUBES PER ROW						
COOLER DIMENSIONS ADJUSTED TO LOWER STEAM VELOCITY, VELC(1) = 0.14584E 03						
12ROWS OF TUBES 27.0A7TUBES PER ROW						
COOLEX DONE						
CONVERGENCE CRITERIA MET FOR EXIT STEAM						
COOLER EXIT STEAM FRAC.	0.0052	ACTUAL TUBES IN CONDENSER	5A75.2	ACTUAL TUBES IN COOLER	32A.8	
TEST CASE CLEANLINESS = .9	T = 124					
SUMMARY OF RESULTS						
AREA AVERAGE	BACK CALC.	TEMP.	STEAM VELOCITY	TUBE SPACING	TUBE FRACTION	HEAT TRF.
U.	LDD MEAN	PRESSURE	FT/SEC	RATIO,	MILLION	SURFACE.
BTU/HR/SQ.FT.	DELTA TEMP,	DROP	INLET	8/D	BTU/HR	
/DEG. F.	DEG.F.	LBS/SQ.IN.	OUTLET	PERCENT		
CONDENSER	39.5478	0.2848	5.7947	1.330	94.59	210.7353
COOLER	564.52	34.3667	4.5251	1.330	5.41	10.2804
OVERALL	581.95	39.3802	13.6101			221.5159
OUTSIDE BUNDLE DIAM., FT.	5.61	INSIDE VOID DIAM., FT.	1.15	NUMBER OF RADIAL TUBE ROWS	37.	
COOLER HEIGHT, FT.	0.77	COOLER WIDTH, FT.	1.93	RUNBLE LENGTH, FT.	9.844	
EXIT STEAM, PERCENT OF INPUT	0.5188	EXIT NON-CONDENSIBLES, PERCENT OF TOTAL	EXIT FLOW		0.33	
AVO. BRINE TEMPS		FLOW				
ENTRANCE		LBS/HR				
EXIT						
CONDENSER	74.9987	89.0367	216999.			
COOLER	75.0000	88.4132	16692840.			
OVERALL	74.9988	88.9726	8.0000 F/8			
			CONDENSATE FROM CONDENSER			
			205378.			
			CONDENSATE FROM COOLER			
			10494.			
DTCMD2	UPCOND	DTCOL2	UPCOOL	DLTOT2	UPAVO	
43.6043	528.5894	37.1503	354.3704	43.6422	523.1213	

Table III. ORCON1 Input and Output for the Verification of the Example Condenser

CASE IDENTIFICATION AND NOTES ****		TEST CASE	CLEANLINESS = .9	T = 126	FLOW AND PROPERTIES SPECIFICATION					
GEOMETRY SPECIFICATION		TUBING SPECIFICATION			FLOW AND PROPERTIES SPECIFICATION					
NO. OF TUBES	4000.00	OUTSIDE DIAM., INCHES	0.6250	STEAM FLOW, LBS/HR	217000.					
PCT. TUBES IN COOLER	5.00	WALL THICKNESS, INCHES	0.0470	COOLANT FLOW, LBS/HR.	0.					
LENGTH OF TUBES, FT.	10.77	WALL CORR., BTU/HR/SQ.F./DEG.F.	26.0000	COOLANT VELOCITY, FT/SEC.	6.5					
S/D, CONDENSER	1.330	FOULING FACTOR	0.0002	STEAM TEMP., DEG. F.	126.00					
S/D, COOLER	1.330	TUBE FLOOD FACTOR(FDAVE)	1.0000	COOLANT TEMP., DEG. F.	75.00					
BUNDLE RADIUS FACTOR	1.00	ENHANCEMENT FACTOR(B)	1.0000	WT. FRAC. OF NAEL IN COOLANT	0.03500					
SECTOR MODEL	6.00	INSIDE FILM	1.0000	EXIT STEAM FRACTION/PCT. OF INPUT	0.0					
BAFFLE FLAG	0.0	OUTSIDE FILM	1.0000	NON-CONDENSIBLE FLOW, LB/HR.	4.00					
BYN. FLAG	1.00	FRICTION FACTOR	1.0000							
COOLER EXIT STEAM FRAC. 0.0001 ACTUAL TUBES IN CONDENSER 5675.2 ACTUAL TUBES IN COOLER 324.8										
TEST CASE CLEANLINESS = .9 T = 126										
SUMMARY OF RESULTS										
AREA AVERAGE	BACK CALC.	PRESSURE	TEMP.	STEAM VELOCITY	TUBE SPACING	TUBE RATIO	TURF FRACTION	HEAT TRF.		
BTU/HR/SQ.FT.	LOG MEAN	DRUP	DEG.F.	FT/SEC	RATIO,	8/D	PERCENT	MILLION		
/DEG. F.	DEG.F.	LBS/SQ.IN.		INLET	OUTLET			BTU/HR		
								SO.FT.		
CONDENSER	546.39	30.4173	0.2419	4.8164	225.34	77.23	1.330	94.59	209.8904	9999.19
COOLER	563.08	35.7193	0.0299	0.7490	150.08	24.54	1.330	5.41	11.5104	572.28
OVERALL	547.29	30.2671	0.3312	6.7170					221.4007	10571.47
OUTSIDE BUNDLE DIAM., FT. 5.61 INSIDE VOID DIAM., FT. 1.15 NUMBER OF RADIAL TUBE ROWS 37.										
COOLER HEIGHT, FT. 0.83 COOLER WIDTH, FT. 1.78 BUNDLE LENGTH, FT. 10.768										
EXIT STEAM, PERCENT OF INPUT 0.5088 EXIT NON-CONDENSIBLES, PERCENT OF TOTAL EXIT FLOW 0.54										
AVG. BRINE TEMPS										
ENTRANCE		EXIT		FLOWS						
CONDENSER		COOLER		LBS/HR						
74.9994	92.2037	STEAM TO CONDENSER		217000.						
74.9998	91.4006	COOLANT TO BUNDLE		13562928.						
74.9994	92.1294	COOLANT VELOCITY		6.5000 F/8						
		CONDENSATE FROM CONDENSER		204480.						
		CONDENSATE FROM COOLER		11216.						
DICND2	UPCOND	DICOL2	UPCOOL	DLTOT2	UPAVO					
41.8102	502.0486	36.5364	550.4917	41.8530	500.3994					
R/ T-40.61/41.94 16.52.18										

Table IV. Data for Test Runs A.1.1 to A.4.1 for the DDG-37 Class Test Condenser

Item No.	Item	Source	Units				B-1.2 1st V.P.
			A-1.1 15 Knots	A-1.2 20 Knots	A-2.1 25 Knots	A-4.1 30 Knots	
1	Exhaust Flow to Condenser	Previous Calc.	lbs/hr	40,834.56	72,654.05	161,961.90	44,097.22
2	Exhaust Enthalpy	Previous Calc.	Btu/lb	1097.06	1054.75	1053.67	1049.77
3	Inter Condenser Drain Flow	Previous Calc.	lbs/hr	285.24	311.59	299.05	298.10
4	Inter Condenser Drain Temperature	TC-181	°F	130.50	123.64	116.29	126.60
5	Inter Condenser Drain Enthalpy		Btu/lb	98.40	91.55	84.22	94.51
6	Condensate Temperature	Ave. TC-177, 178	°F	83.57	87.01	90.51	86.34
7	Condensate Enthalpy		Btu/lb	51.58	55.05	58.50	68.97
8a	Heat Load	(1) ((2)-(7)) + (3) ((5)-(7))	Btu/hr x 10 ³	23,787.1	40,833.7	71,390.3	43,907.7
8b	Heat Load without Sub-cooling	(8a) - ((1)+(3)) ((1)-(6))	Btu/hr x 10 ³	X	40,819.7	71,262.6	43,907.7
9	Condenser Pressure	Previous Calc.	Psia	0.556	0.645	0.751	1.294
10	Condenser Pressure	(9) x 2.046	In. Hg. Abs.	1.132	1.313	1.529	2.635
11	Saturation Temperature	@ (10)	°F	82.84	87.48	92.33	84.62
12	Circulating Water Inlet Temperature	Ave. WT-101, 102	°F	76.77	76.92	75.79	76.40
13	Circulating Water Outlet Temperature	Ave. WT-103, 104, 105, 106	°F	79.64	80.73	81.49	87.27
14	Circulating Water Temperature Rise	(13) - (12)	°F	2.87	3.86	5.70	10.61
15	L.M.T.D.	T _v highest of 6 & 11	°F	5.236	8.485	13.491	28.241
16	Test Heat Transfer Coefficient	(8) ÷ (15) ÷ Surface	Btu/hr-sq ft-°F	516.0	546.6	601.0	635.2
17	Circulating Water Flow	(8a) ÷ (14)	1000 lbs/hr	8288.2	10,578.7	12,524.6	15,031.8
18	Circulating Water Velocity	17 xsp Vol ÷ 3600 ÷ Flow Area	ft/sec	4.669	5.963	7.060	8.473
19	Uncorrected "U"	HT Stds. @ (18)	Btu/hr-sq ft-°F	583.47	659.07	717.39	785.70
20	Corrected "U"	(19) x F _c x F _m	Btu/hr-sq ft-°F	541.93	613.93	664.37	729.05
21	Apparent Cleanliness	(16) ÷ (20) x 100	%	95.2	89.0	90.5	87.1
							95.0

Table V. ORCONL Results for Run A.1.1

CASE IDENTIFICATION AND NOTES **** DLO RUN A.1.1 CLEANLINESS = .9 T = 82.84

GEOMETRY SPECIFICATION TUBING SPECIFICATION FLOW AND PROPERTIES SPECIFICATION

NO. OF TUBES 5230.00 OUTSIDE DIAM., INCHES 0.6250 STEAM FLOW, LBS/HR 22740.
 PCT. TUBES IN COOLER 7.00 WALL THICKNESS, INCHES 0.0490 COOLANT FLOW, LBS/HR. 0.
 LENGTH OF TUBES, FT. 10.29 WALL COND., BTU/HR/SQ.F/DEG.F. 25.0000 COOLANT VELOCITY, FT/SEC. 4.7
 S/D. COOLER 1.400 FOULING FACTOR 0.0002 STEAM TEMP., DEG. F. 82.04
 S/D. COOLER 1.300 TUBE FLOOR FACTOR(DRAVE) 1.0000 COOLANT TEMP., DEG. F. 76.77
 BUNDLE RADIUS FACTOR 1.00 ENHANCEMENT FACTORS HT. FRAC. OF NAEL IN COOLANT 0.0
 SECTOR MODEL 6.00 INSIDE FILM 1.0000 EXIT STEAM FRACTION-PCT. OF INPUT 0.0
 BAFFLE FLAG 0.0 OUTSIDE FILM 1.0000 NON-CONDENSIBLE FLOW, LB/HR. 7.66
 SYH. FLAG 1.00 FRICTION FACTOR 1.0000

COOLER EXIT STEAM FRAC. 0.1662 ACTUAL TUBES IN CONDENSER 4051.7 ACTUAL TUBES IN COOLER 378.3
 DLO RUN A.1.1 CLEANLINESS = .9 T = 82.84

SUMMARY OF RESULTS

AREA AVERAGE	BACK CALC.	TEMP.	STEAM VELOCITY	TUBE SPACING	TUBE FRACTION	HEAT			
U,	LOG MEAN	DROP	FT/SEC	RATIO,	REMOVED,	SURFACE,			
BTU/HR/SQ.FT. DELTA TEMP,	DROP	LBS/SQ.IN.,	DEG.F.,	S/D	MILLION	BTU/HR			
/DEG. F.	DEG.F.	DEG.F.	INLET	OUTLET	PERCENT	50.FT.			
CONDENSER 536.23	4.2816	0.0168	0.9746	73.66	73.58	1.400	92.77	18.7549	8168.75
COOLER 551.57	3.1575	0.0109	1.1172	147.21	121.49	1.300	7.23	1.1094	636.99
OVERALL 537.34	4.1902	0.0425	2.4755					19.8643	8805.74

OUTSIDE BUNDLE DIAM., FT. 5.47 INSIDE VOID DIAM., FT. 1.16 NUMBER OF RADIAL TUBE ROWS 34.
 COOLER HEIGHT, FT. 0.70 COOLER WIDTH, FT. 2.30 BUNDLE LENGTH, FT. 10.290

EXIT STEAM, PERCENT OF INPUT ***** EXIT NON-CONDENSIBLES, PERCENT OF TOTAL EXIT FLOW 0.20

AVO. BRINE TEMP'S	FLOW
ENTRANCE	LBS/HR
CONDENSER 76.7706	22740.
COOLER 76.7700	8322186.
OVERALL 76.7705	4.6990 F/S

STEAM TO CONDENSER 22740.
 COOLANT TO BUNDLE 8322186.
 COOLANT VELOCITY 4.6990 F/S
 CONDENSATE FROM CONDENSER 17904.
 CONDENSATE FROM COOLER 1056.

DTCND2 UPCOND DTCOL2 UPFCOOL DLTOT2 UPAVO
 4.7505 483.3000 4.0322 431.9211 4.7978 470.1802

Table VI. ORCONI Results for Run A.1.1.2

CASE IDENTIFICATION AND NOTES **** DLG RUN A.1.1.2 CLEANLINESS = .9 T = 87.48

GEOMETRY SPECIFICATION TUBING SPECIFICATION FLOW AND PROPERTIES SPECIFICATION

NO. OF TUBES	OUTSIDE DIAM., INCHES	STEAM FLOW, LBS/HR
PCT. TUBES IN COOLER	WALL THICKNESS, INCHES	COOLANT FLOW, LBS/HR.
LENGTH OF TUBES, FT.	WALL COND., BTU/HR/SM.F/DEG.F.	COOLANT VELOCITY, FT/SEC.
S/D, CONDENSER	FOULING FACTOR	STEAM TEMP., DEG. F.
S/D COOLER	TUBE FLOOD FACTOR(FDAVE)	COOLANT TEMP., DEG. F.
BUNDLE RADIUS FACTOR	ENHANCEMENT FACTORS	WT. FRAC. OF NACL IN COOLANT
SECTOR MODEL	INSIDE FILM	EXIT STEAM FRACTION,PCT. OF INPUT
RAFFLE FLAG	OUTSIDE FILM	NON-CONDENSIBLE FLOW, LB/HR.
SYM. FLAG	FRICTION FACTOR	

COOLER EXIT STEAM FRAC. 0.0833 ACTUAL TUBES IN CONDENSER 4851.7 ACTUAL TUBES IN COOLER 378.3

DLO RUN A.1.1.2 CLEANLINESS = .9 T = 87.48

SUMMARY OF RESULTS

AREA AVERAGE	BACK CALC.	PRESSURE	TEMP.	STEAM VELOCITY	TUBE BEACING	TUBE FRACTION	HEAT
U.	LOG MEAN	DROP	DEG.F.	FT/SEC	RATIO	REMOVED	HEAT TRF.
BTU/HR/SQ.FT.	DELTA TEMP,	LBS/SQ.IN.	DEG.F.	INLET	S/D	MILLION	SURFACE,
/DEG. F.				OUTLET		BTU/HR	SG.FT.
CONDENSER	588.92	0.0320	1.6228	114.87	1.400	92.77	36.6768
COOLER	609.83	0.0149	0.7930	141.11	1.300	7.23	2.4541
OVERALL	590.44	0.0541	2.8828				39.1308

OUTSIDE BUNDLE DIAM., FT. 5.47 INSIDE VOID DIAM., FT. 1.16 NUMBER OF RADIAL TUBE ROWS 34.

COOLER HEIGHT, FT. 0.64 COOLER WIDTH, FT. 2.61 BUNDLE LENGTH, FT. 10.290

EXIT STEAM, PERCENT OF INPUT 8.3328 EXIT NON-CONDENSIBLES, PERCENT OF TOTAL EXIT FLOW 0.19

AVG. BRINE TEMPS	FLOWS	
ENTRANCE	LBS/HR	
EXIT		
CONDENSER	76.9193	80.6667
COOLER	76.9199	80.1334
OVERALL	76.9194	80.5947

STEAM TO CONDENSER	40835.	
COOLANT TO BUNDLE	10540504.	
COOLANT VELOCITY	5.9430	F/8
CONDENSATE FROM CONDENSER	35087.	
CONDENSATE FROM COOLER	2345.	

BTCHD2	UPCOND	BTCOL2	UPCOOL	DLTOT2	UPAVO
8.5506	525.0977	7.0293	546.0771	8.5923	517.1804

Table VII. ORCONI Results for Run A.2.1

CASE IDENTIFICATION AND NOTES *** DLO RUN A.2.1 CLEANLINESS = .9 T = 92.33

GEOMETRY SPECIFICATION TUBING SPECIFICATION FLOW AND PROPERTIES SPECIFICATION

NO. OF TUBES	5230.00	OUTSIDE DIAM., INCHES	0.6350	STEAM FLOW, LBS/HR	72654.
PCT. TUBES IN COOLER	7.00	WALL THICKNESS, INCHES	0.0490	COOLANT FLOW, LBS/HR	0.
LENGTH OF TUBES, FT.	10.29	WALL COND., BTU/HR/SQ.FT/DEG.F.	28.0000	COOLANT VELOCITY, FT/SEC.	7.1
S/D, CONDENSER	1.400	FOULING FACTOR	0.0002	STEAM TEMP., DEG. F.	92.33
S/D COOLER	1.300	TUBE FLOOD FACTOR (FDLAVE)	1.0000	COOLANT TEMP., DEG. F.	75.79
BUNDLE RADIUS FACTOR	1.00	ENHANCEMENT FACTORS	1.0000	WT. FRAC. OF NACL IN COOLANT	0.0
SECTOR MODEL	6.00	INSIDE FILM	1.0000	EXIT STEAM FRACTION, PCT. OF INPUT	0.0
BAFFLE FLAG	0.0	OUTSIDE FILM	1.0000	NON-CONDENSIBLE FLOW, LB/HR.	6.10
SYM. FLAG	1.00	FRICTION FACTOR	1.0000		

COOLER EXIT STEAM FRAC. 0.1929 ACTUAL TUBES IN CONDENSER 4851.7 ACTUAL TUBES IN COOLER 378.3

DLO RUN A.2.1 CLEANLINESS = .9 T = 92.33

SUMMARY OF RESULTS

AREA AVERAGE	BACK CALC.	TEMP.	STEAM VELOCITY	TUBE SPACING	TUBE FRACTION	HEAT
U,	LOG MEAN	DROP	FT/SEC	RATIO	MILLION	HEAT TRF.
BTU/HR/50.FT.	DELTA TEMP,	LBS/SQ.IN.,	DEG.F.	S/D	BTU/HR	SURFACE.
/DEG. F.	DEG.F.	INSIDE	INLET	PERCENT		
CONDENSER	605.49	0.1054	4.8779	1.400	92.77	57.6294
COOLER	639.80	0.0045	0.2271	1.300	7.23	3.6061
OVERALL	607.97	0.1231	5.6942			61.2355

OUTSIDE BUNDLE DIAM., FT. 5.47 INSIDE VOID DIAM., FT. 1.16 NUMBER OF RADIAL TUBE ROWS 34.

COOLER HEIGHT, FT. 0.23 COOLER WIDTH, FT. 8.59 BUNDLE LENGTH, FT. 10.290

EXIT STEAM, PERCENT OF INPUT ***** EXIT NON-CONDENSIBLES, PERCENT OF TOTAL EXIT FLOW 0.04

AVG. BRINE TEMPS

ENTRANCE	EXIT	FLOW
		LBS/HR
CONDENSER	75.7805	80.7601
COOLER	75.7900	79.7769
OVERALL	75.7887	80.6274
		STEAM TO CONDENSER
		COOLANT TO BUNDLE
		COOLANT VELOCITY
		CONDENSATE FROM CONDENSER
		CONDENSATE FROM COOLER

DTCMD2 UPCOND DTCOL2 UPFCOOL DLTOT2 UPAVG

13.9080 507.2537 9.0891 622.8484 13.9827 497.3308

Table VIII. ORCON1 Results for Run A.4.1

CASE IDENTIFICATION AND NOTES ***** DLO RUN A.4.1 CLEANLINESS = .9 T = 110.52
 FLOW AND PROPERTIES SPECIFICATION

GEOMETRY SPECIFICATION TUBING SPECIFICATION

NO. OF TUBES	5230.00	OUTSIDE DIAM., INCHES	0.6250	STEAM FLOW, LRS/HR	161961.
PCT. TUBES IN COOLER	7.00	WALL THICKNESS, INCHES	0.0490	COOLANT FLOW, LRS/HR.	0.
LENGTH OF TUBES, FT.	10.29	WALL COND. BTU/HR/SW.F/DEG.F.	26.0000	COOLANT VELOCITY, FT/SEC.	8.5
S/D COOLERS	1.400	FOULING FACTOR	0.0002	STEAM TEMP., DEG. F.	110.52
S/D COOLER	1.300	TUBE FLOOD FACTOR(FDFAVE)	1.0000	COOLANT TEMP., DEG. F.	76.66
BUNDLE RADIUS FACTOR	1.00	ENHANCEMENT FACTORB		WT. FRAC. OF NAACL IN COOLANT	0.0
SECTOR MODEL	4.00	INSIDE FILM	1.0000	EXIT STEAM FRACTION,PCT. OF INPUT	0.0
BAFFLE FLAD	0.0	OUTSIDE FILM	1.0000	NON-CONDENSIBLE FLOW, LB/HR.	6.00
BYN. FLAD	1.00	FRICTION FACTOR	1.0000		

COOLER EXIT STEAM FRAC. 0.1979 ACTUAL TUBES IN CONDENSER 4851.7 ACTUAL TUBES IN COOLER 378.3
 DLO RUN A.4.1 CLEANLINESS = .9 T = 110.52

SUMMARY OF RESULTS

AREA AVERAGE	BACK CALC.	TEMP.	STEAM VELOCITY	TUBE SPACING	TUBE FRACTION	HEAT			
U ₁	LOG MEAN	USOP	FT/SEC	RATIO,	PERCENT	REMOVED, SURFACE,			
BTU/HR/50.FT. DELTA TEMP,	PRESSURE	DEG.F.	INLET	S/D		MILLION			
/DEG. F.,	DROP	REG.F.	OUTLET			BTU/HR			
	LRS/SQ.IN.					SQ.FT.			
CONDENSER	24.9642	0.3089	9.4824	235.84	344.02	1.400	92.77	126.3967	8168.75
COOLER	665.03	19.4063	0.0045	0.1580	127.28	114.93	1.300	7.23	8.2208
OVERALL	623.09	24.5350	0.3458	10.5356					134.6175

OUTSIDE BUNDLE DIAM., FT. 5.47 INSIDE VOID DIAM., FT. 1.16 NUMBER OF RADIAL TUBE ROWS 34.

COOLER HEIGHT, FT. 0.17 COOLER WIDTH, FT. 12.86 BUNDLE LENGTH, FT. 10.290
 EXIT STEAM, PERCENT OF INPUT ***** EXIT NON-CONDENSIBLES, PERCENT OF TOTAL EXIT FLOW 0.02

AVD. BRINE TEMPS	FLWS			
ENTRANCE	LBS/HR			
CONDENSER	76.6590	85.7464	STEAM TO CONDENSER	161961.
COOLER	76.6600	84.2343	COOLANT TO BUNDLE	1500450.
OVERALL	76.6591	85.5424	COOLANT VELOCITY	8.4730 F/8
			CONDENSATE FROM CONDENSER	121979.
			CONDENSATE FROM COOLER	7924.

DTCND2 UPCOND DTCOL2 UPCOOL DLTOT2 UPAVG
 29.0811 532.0710 19.5338 640.6855 29.1944 523.6443

Table IX. Comparison of ORCON1 Output and Data for Runs A.1.1.1 to A.4.1.1 for Heat Load, LMTD, and Pressure Drop

RUN	COMMENTS	HEAT TRANSFER COEFFICIENT (BTU/HR-SQ FT-F)	% CHANGE FROM DATA	LMTD (F)	% CHANGE FROM DATA	PRESSURE DROP (PSIA)	% CHANGE FROM DATA
A.1.1	DATA	516.0	-----	5.24	-----	0.045	-----
A.1.1.1	ORCON1	468.2	-9.26	4.80	-8.40	0.042	-5.55
A.1.1.1	MOD ORCON1	487.3	-5.56	4.75	-9.35	0.042	-5.55
A.1.2	DATA	546.6	-----	8.49	-----	0.096	-----
A.1.2	ORCON1	516.5	-5.51	8.59	1.18	0.056	-41.66
A.1.2	MOD ORCON1	553.1	1.19	8.48	-0.12	0.061	-35.93
A.2.1	DATA	601.0	-----	13.49	-----	0.232	-----
A.2.1	ORCON1	498.0	-17.14	13.97	3.56	0.123	-46.98
A.2.1	MOD ORCON1	557.0	-7.33	13.72	1.63	0.108	-53.45
A.4.1	DATA	635.2	-----	28.34	-----	0.751	-----
A.4.1	ORCON1	523.6	-17.56	29.19	3.36	0.346	-53.92
A.4.1	MOD ORCON1	620.5	-2.32	28.40	0.57	0.255	-66.04

Table X. Comparison of ORCON1 Output to the Test Data for Runs A.1.1 to A.4.1 for Heat Load, Cooling Water Temperature and Exit Fraction

RUN	COMMENTS	HEAT LOAD (BTU/HR) (X 10 ⁻³)	% CHANGE FROM DATA	COOLING WATER OUTLET TEMP (F)	% CHANGE FROM DATA	EXIT FRACTION (%)
A.1.1	DATA	23787.1	-----	79.64	-----	-----
A.1.1	ORCON1	19864.3	-16.49	79.12	-0.64	16.62
A.1.1	MOD ORCON1	20386.9	-14.29	79.20	-0.55	14.42
A.1.2	DATA	40833.7	-----	80.78	-----	-----
A.1.2	ORCON1	39130.8	-4.17	80.59	-0.23	8.33
A.1.2	MOD ORCON1	41285.3	1.11	80.09	-0.85	3.28
A.2.1	DATA	71390.3	-----	81.49	-----	-----
A.2.1	ORCON1	61235.5	-14.22	80.63	-1.06	19.29
A.2.1	MOD ORCON1	67229.5	-5.83	81.11	-0.46	11.35
A.4.1	DATA	159487.4	-----	87.27	-----	-----
A.4.1	ORCON1	134617.5	-15.60	85.54	-1.98	19.79
A.4.1	MOD ORCON1	155217.4	-2.68	86.94	-0.38	7.39

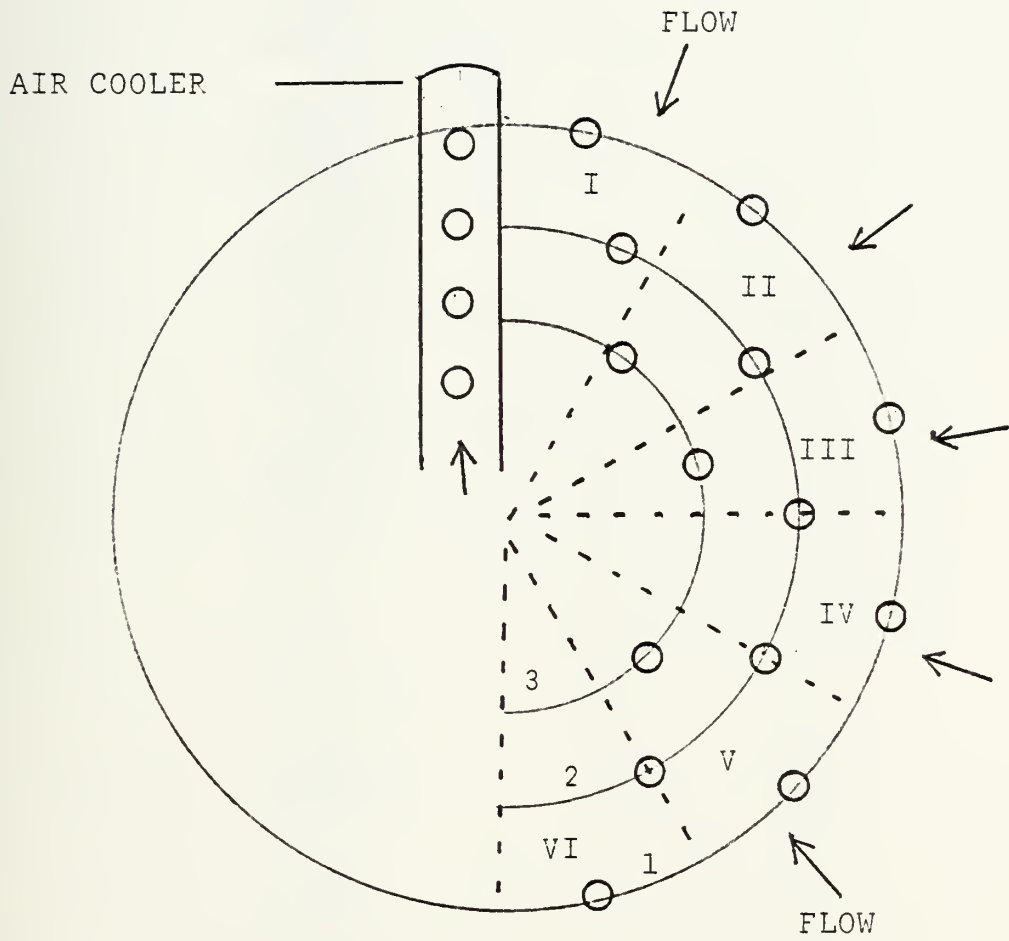

ORCON1 CONDENSER MODEL

I to VI - Sectors
 1 to 3 - Rows

Figure 1. ORCON1 Condenser Model

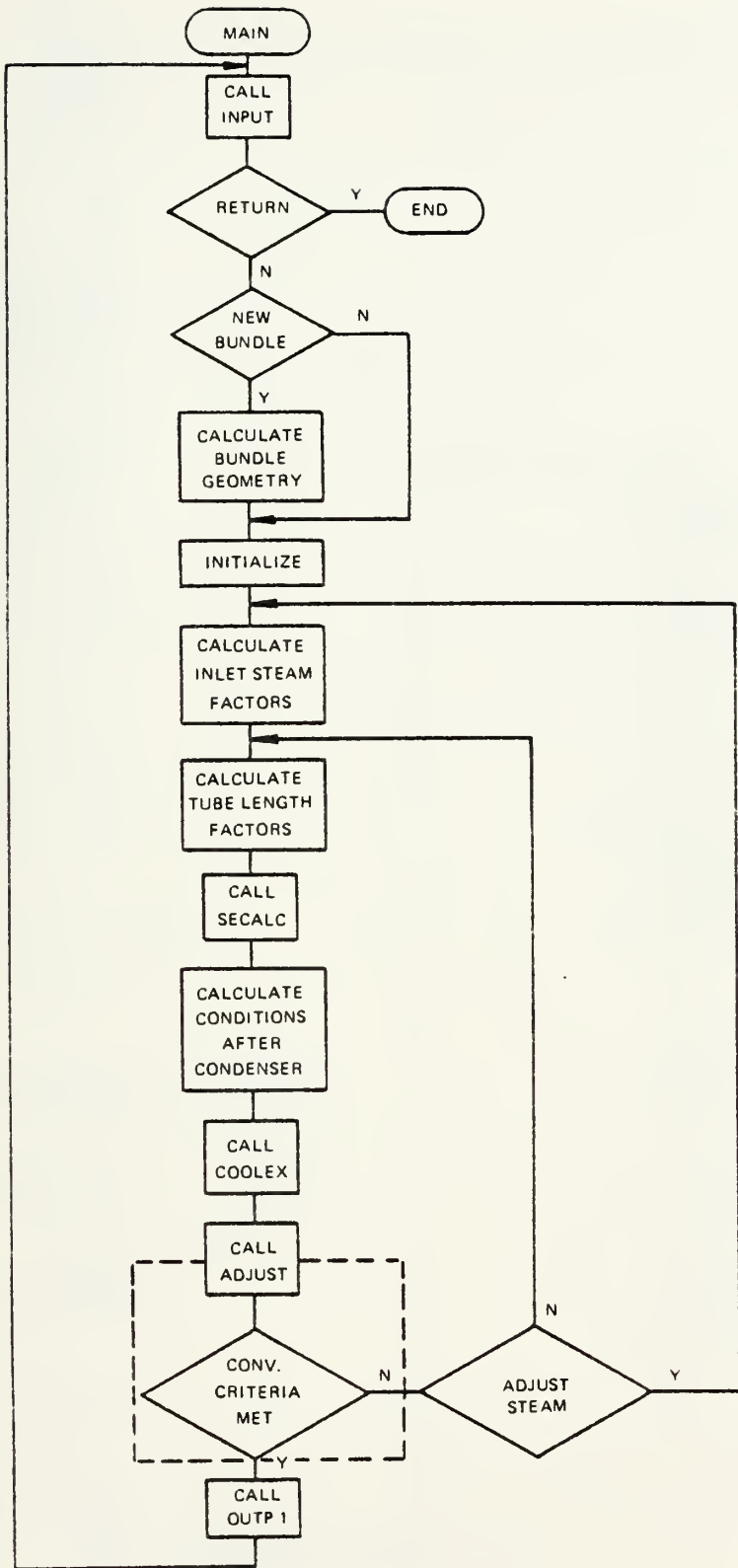

Figure 2. Flow Chart of the ORCON1 Program [4]

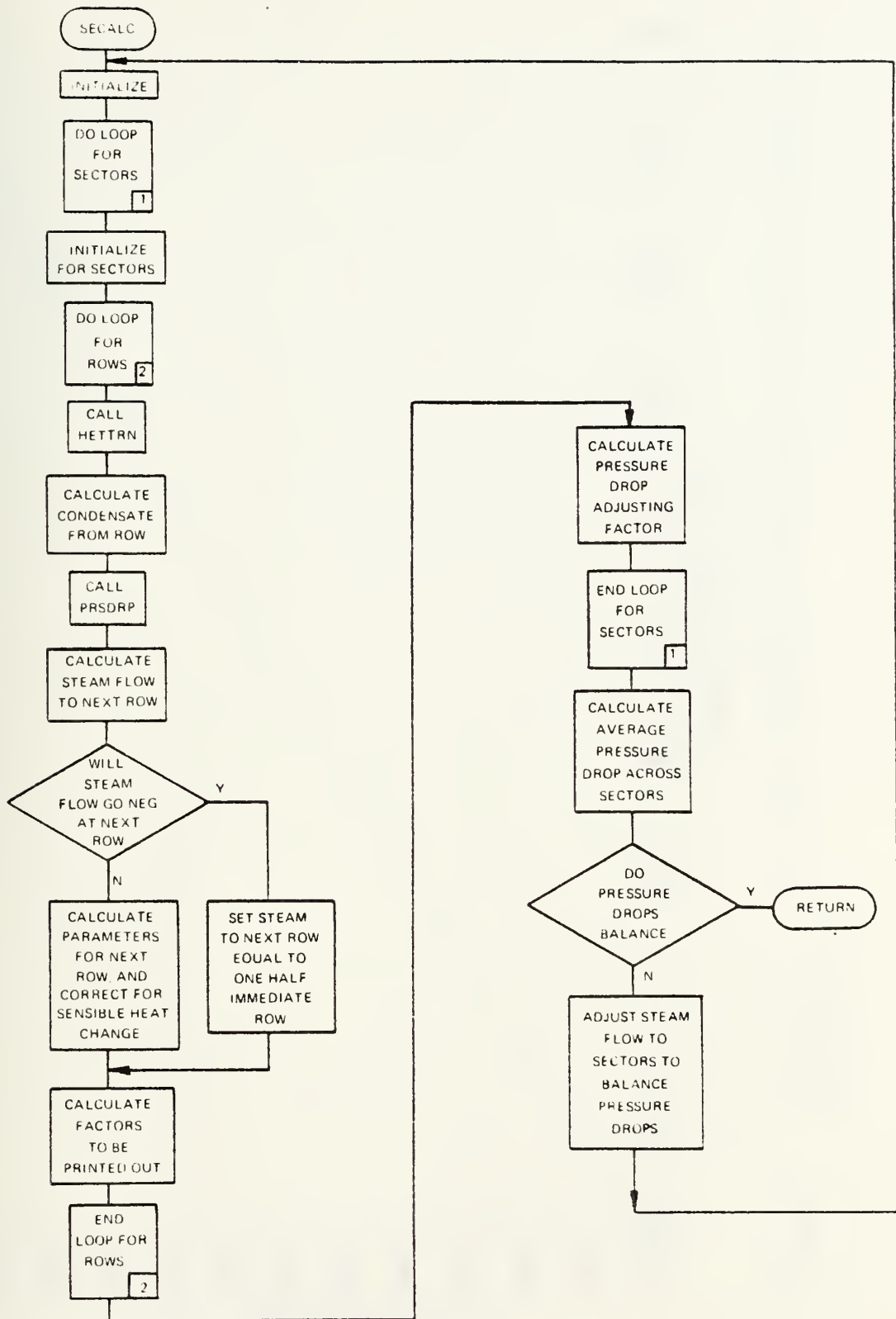

Figure 3. Flow Chart for the Subroutine SECALC [4]

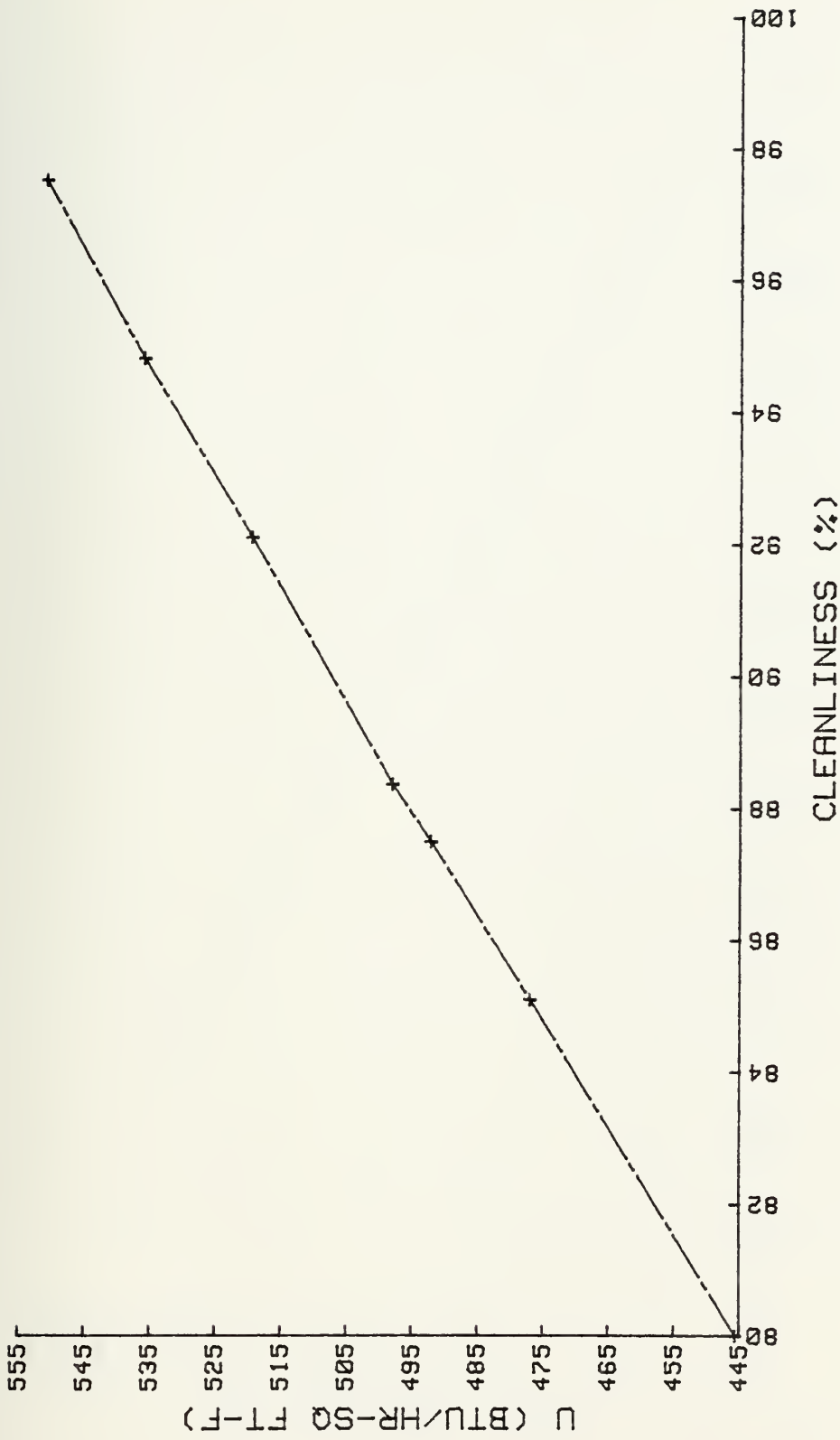

Figure 4. Dependence of the Heat Transfer Coefficient on the Tube Cleanliness for Run A.2.1

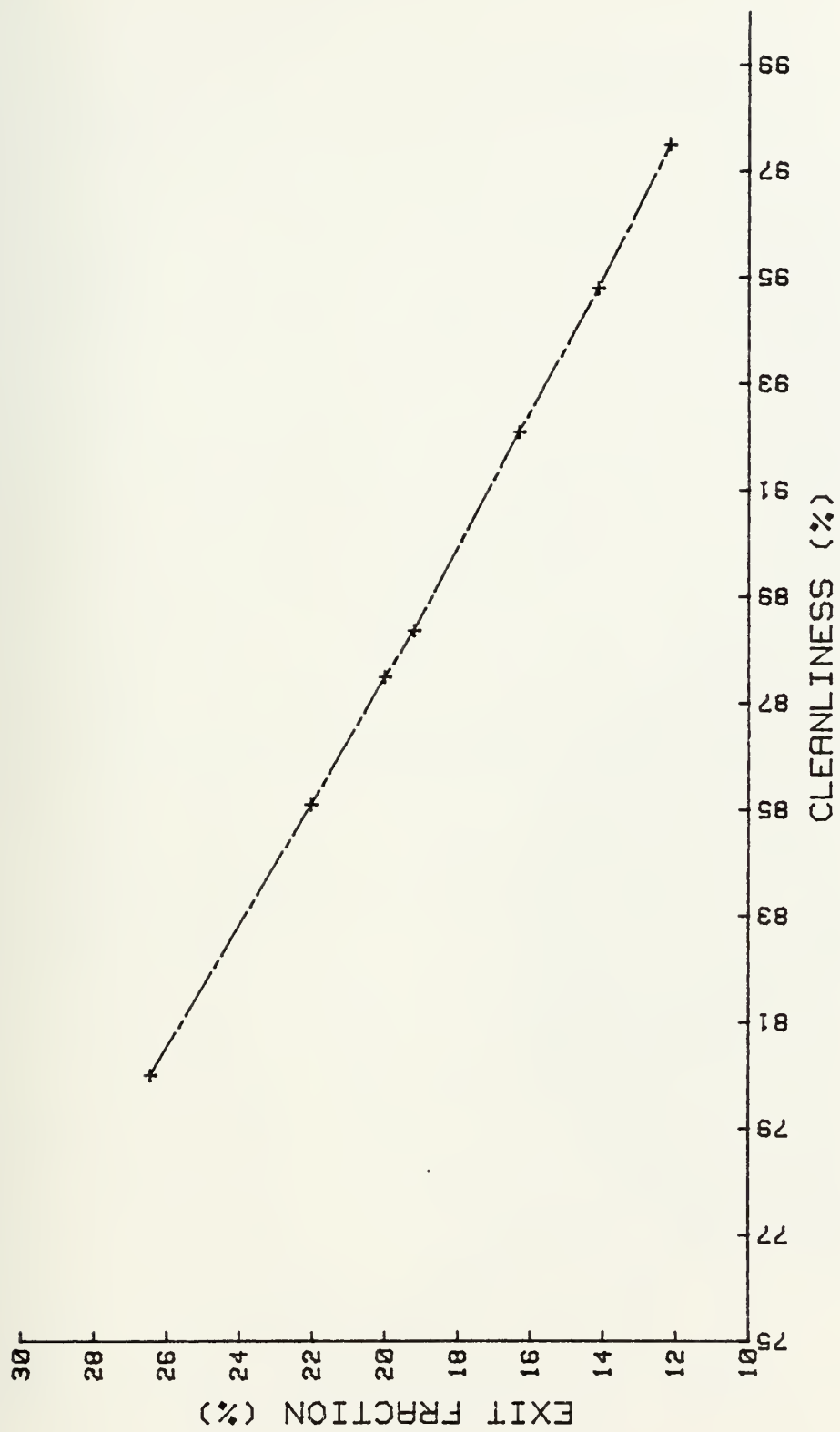

Figure 5. Dependence of the Exit Fraction on the Tube Cleanliness for Run A.2.1

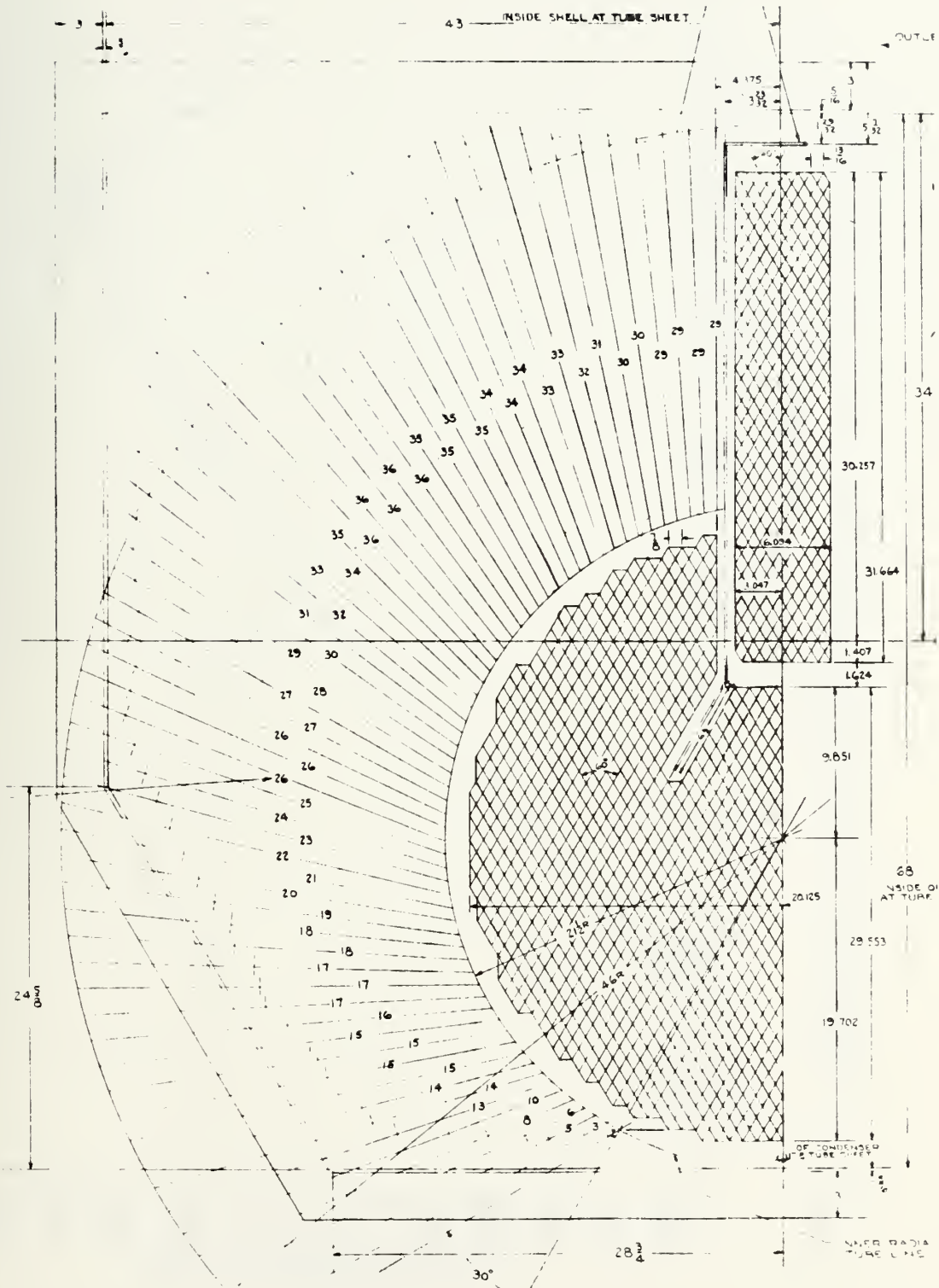

Figure 6. Cutaway View of the Main Condenser of the DDG-37 Class Ships [5]

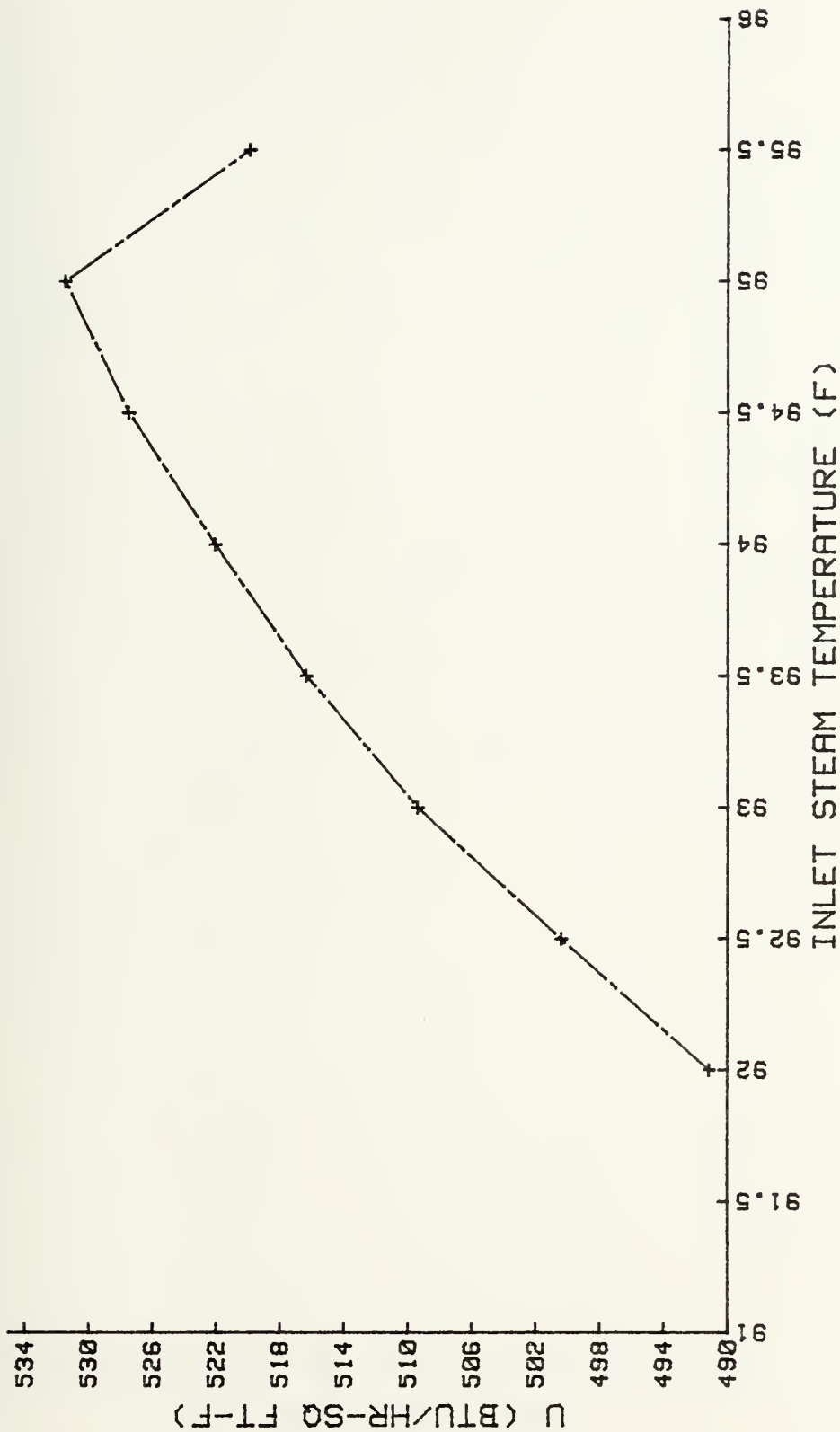

Figure 7. Effect of the Inlet Steam Temperature on the Heat Transfer Coefficient for Run A.2.1

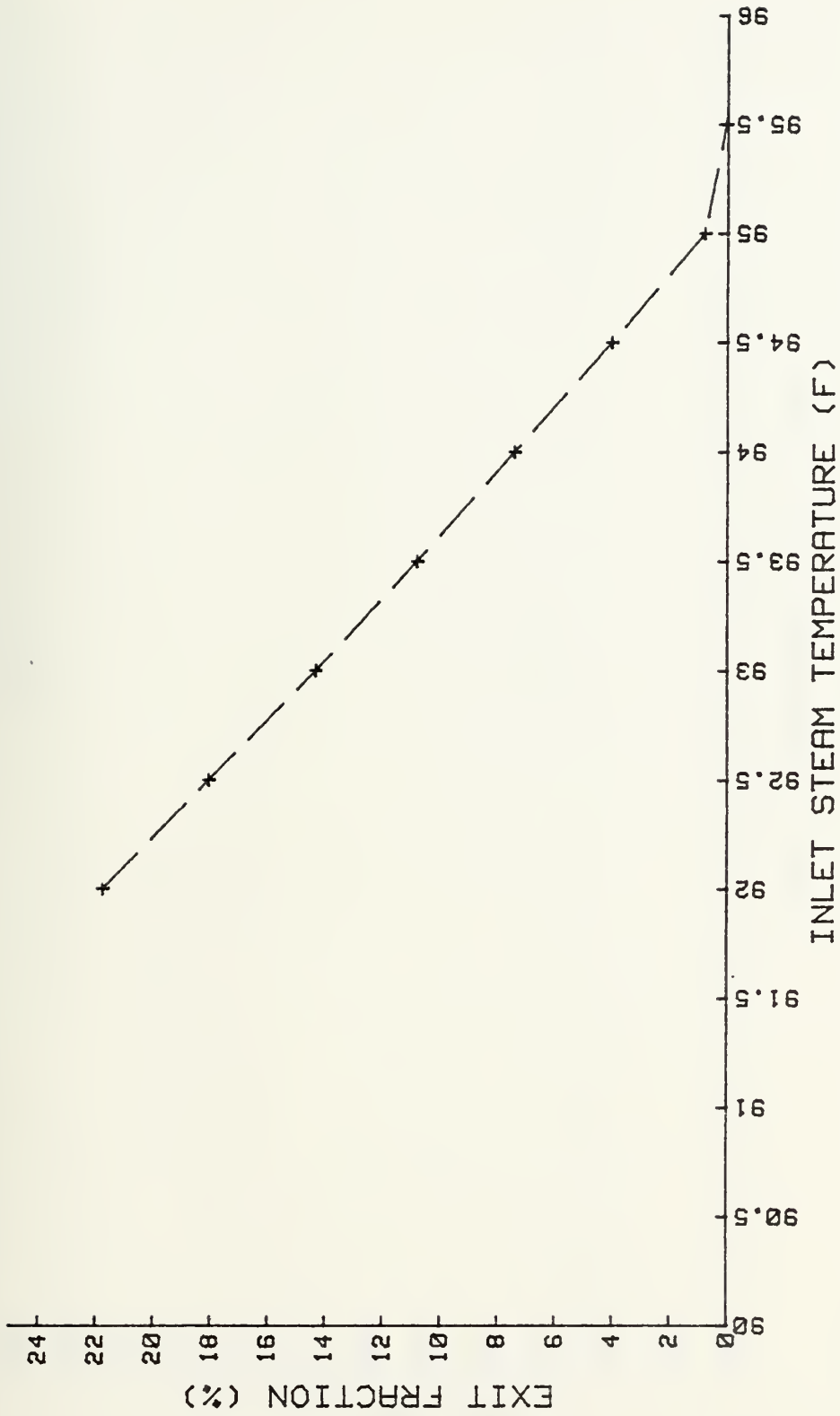

Figure 8. Effect of the Inlet Steam Temperature on the Exit Fraction for Run A.2.1

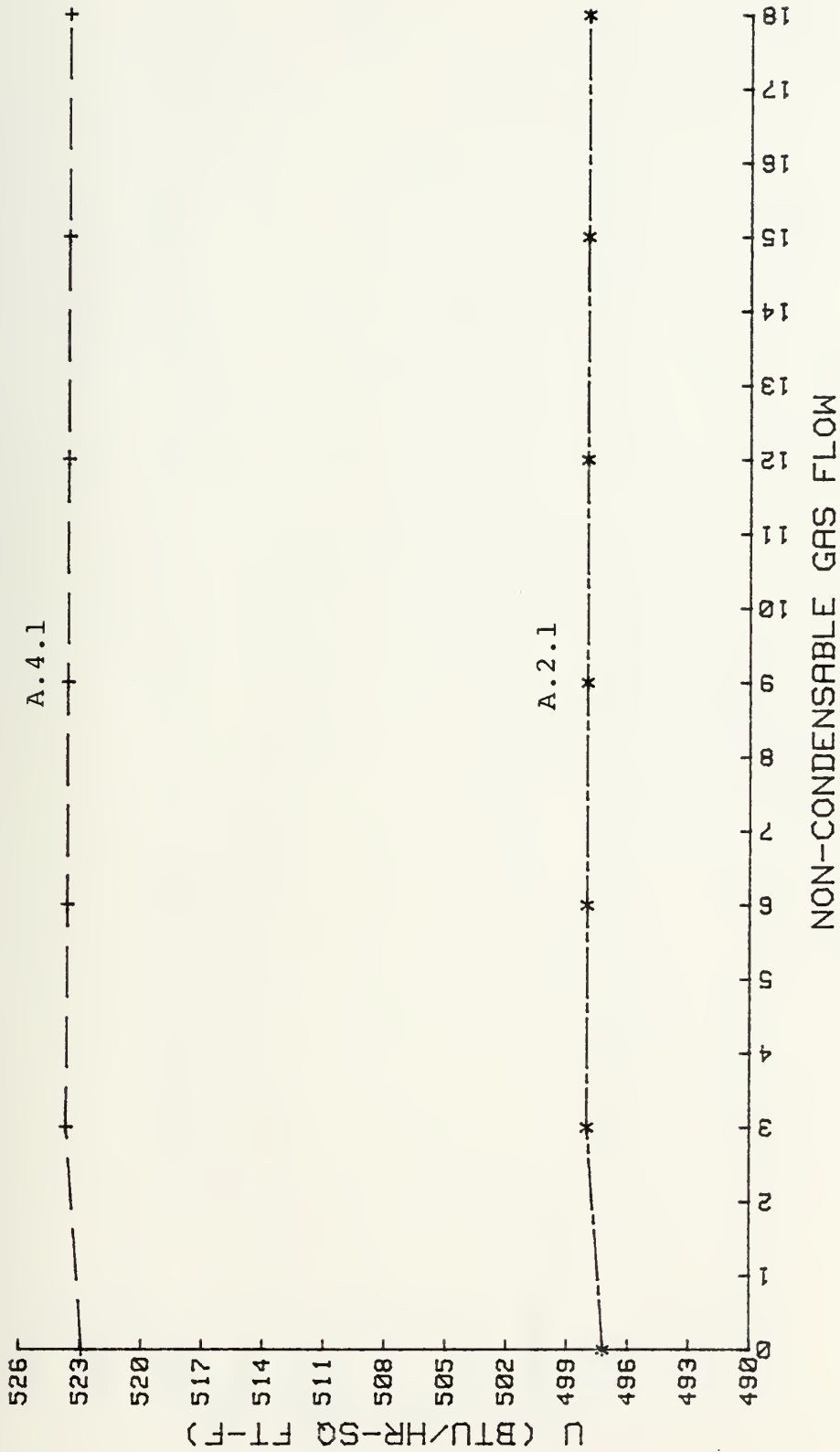

Figure 9. Relationship Between the Heat Transfer Coefficient and the Non-Condensable Gas Flow for Runs A.2.1 and A.4.1

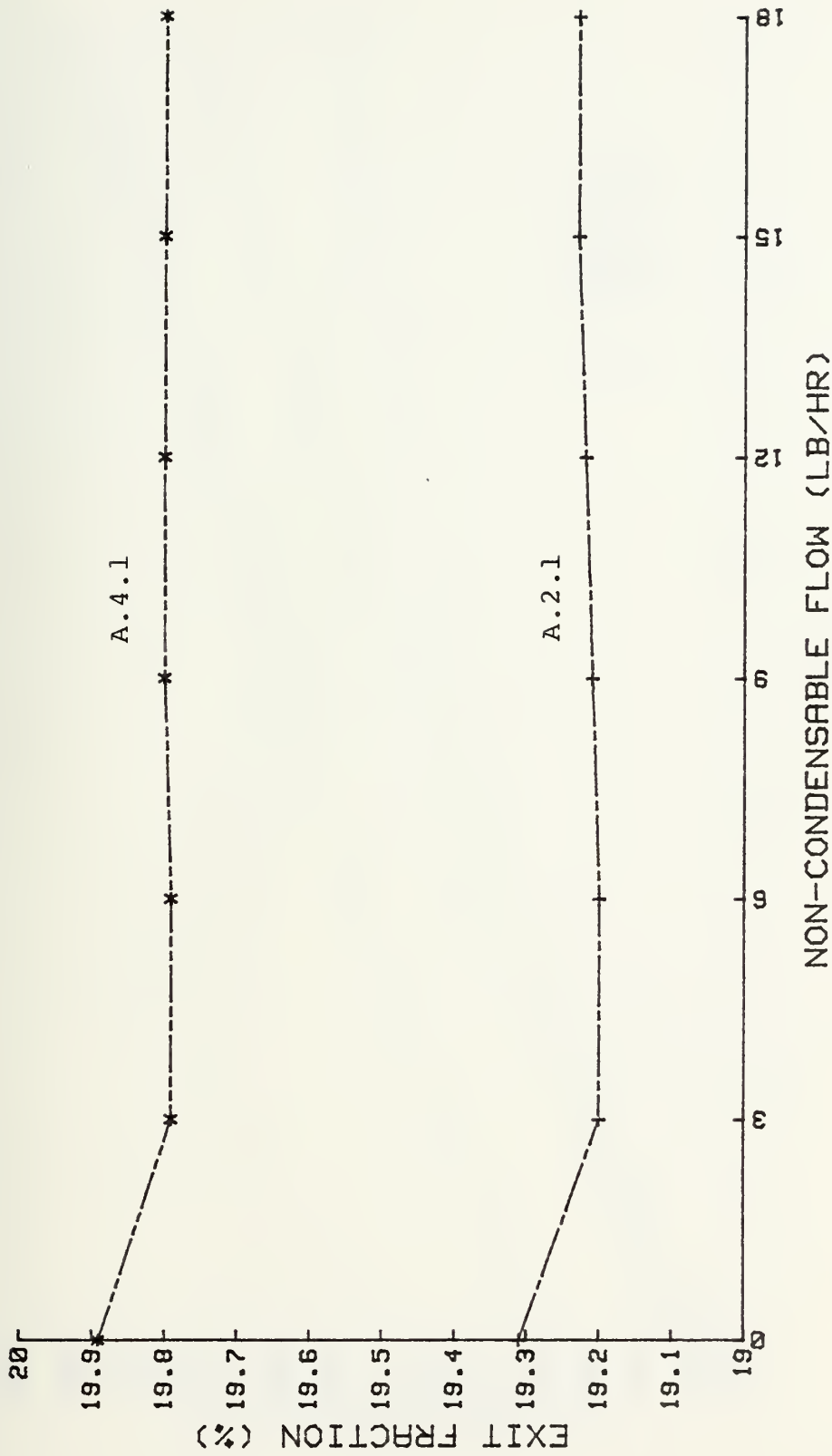

Figure 10. Relationship Between the Exit Fraction and Non-Condensable Gas Flow for Runs A.2.1 and A.4.1

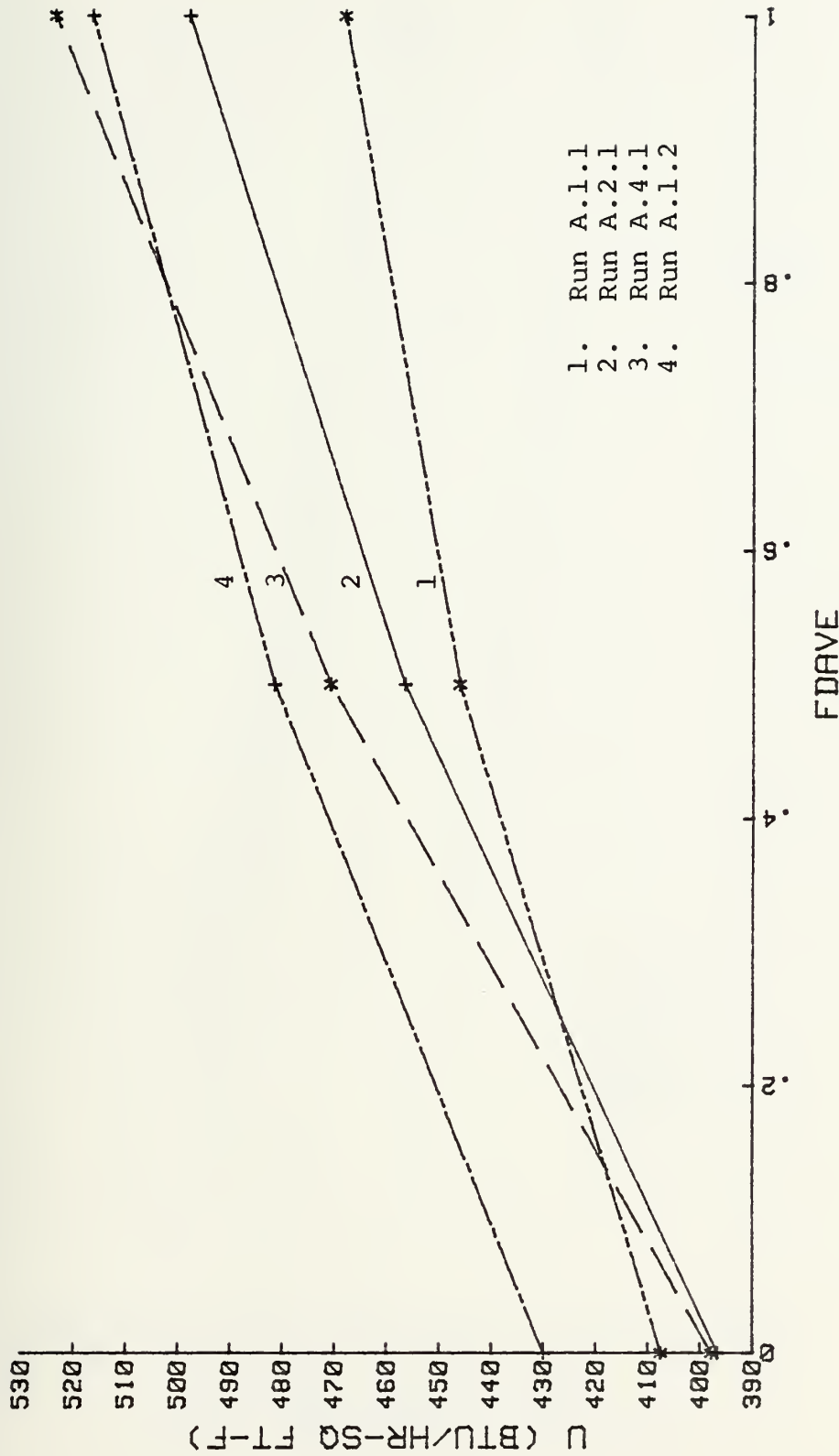
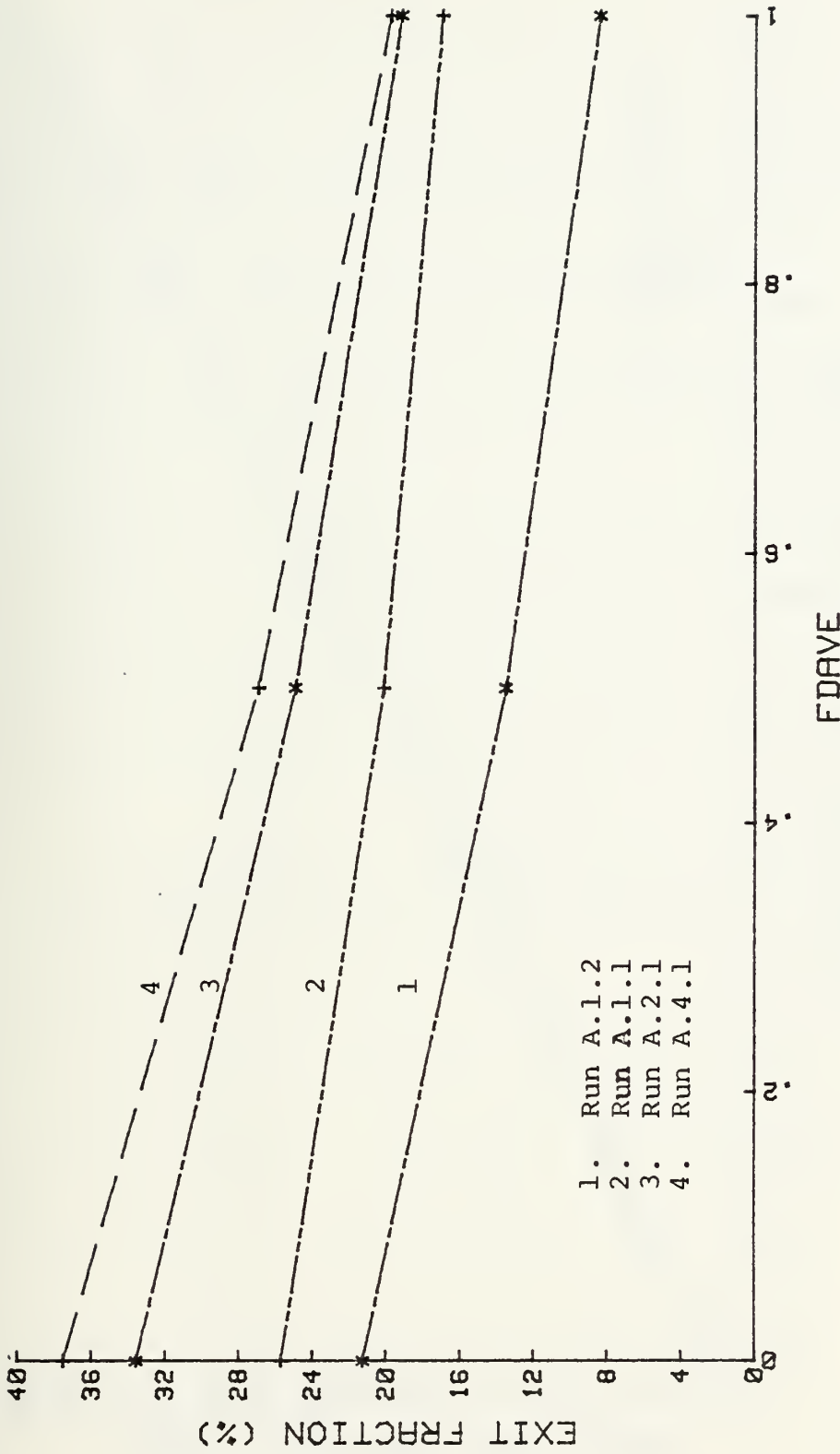

Figure 11. Effect of FDAVE on Heat Transfer Coefficient for Runs A.1.1.1 to A.4.1



- 1. Run A.1.1.2
- 2. Run A.1.1.1
- 3. Run A.2.1.1
- 4. Run A.4.1.1

Figure 12. Effect of FDAVE on Exit Fraction for Runs A.1.1 to A.4.1

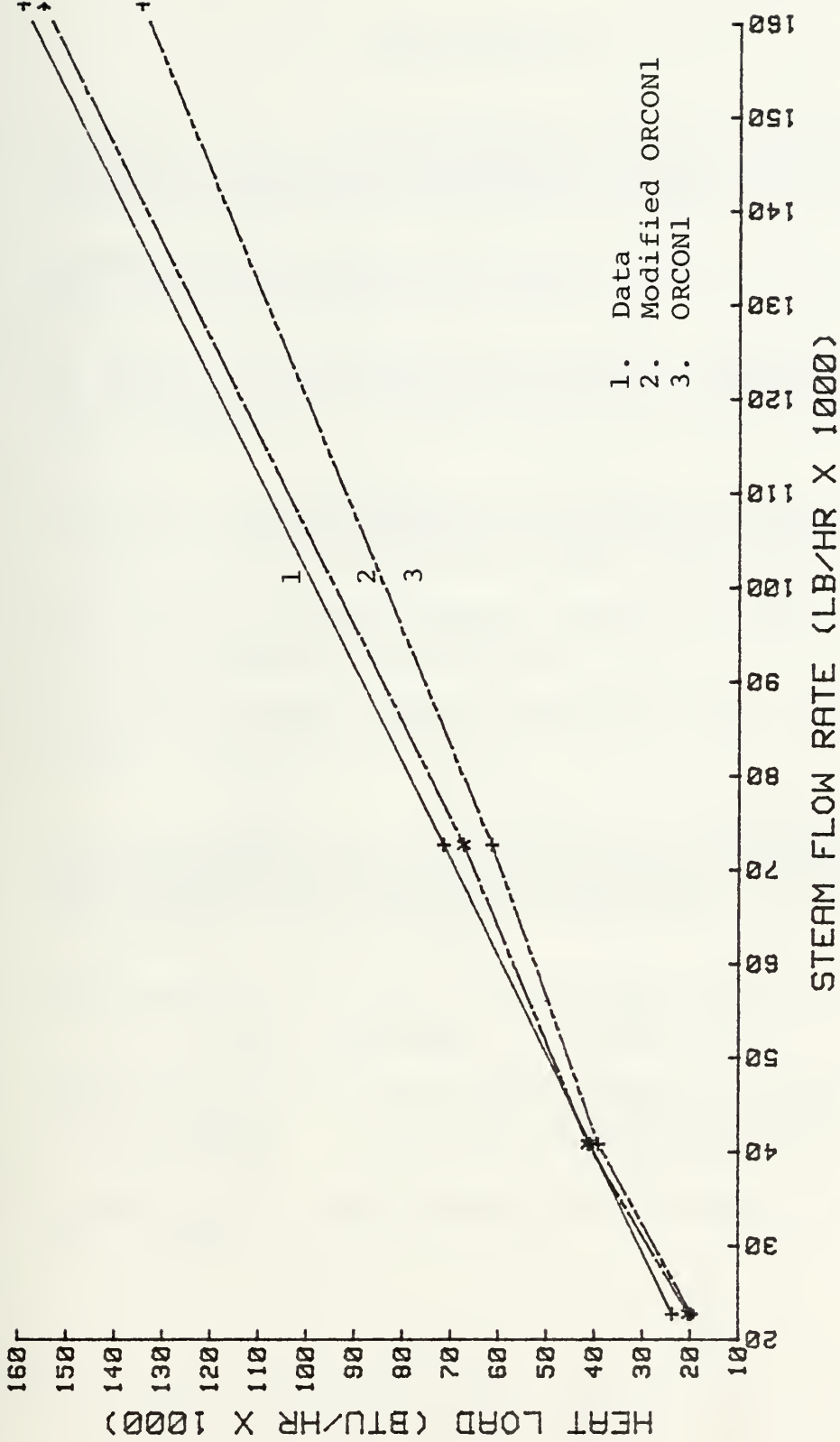

Figure 13. Relationship Between Heat Load and Steam Flow Rate for Runs A.1.1.1 to A.4.1

BIBLIOGRAPHY

1. Sebal, J. F., A Developmental History of Steam Surface Condensers Used in the Electric Utility Industry, Gilbert/Commonwealth Companies, 1979.
2. Standards for Steam Surface Condensers, 6th Edition, Heat Exchange Institute, 1970
3. Sawyer, J. W., "Marine Gas Turbines - Status Report" in Sawyer's Gas Turbine Engineering Handbook, Vol. II, edited by John W. Sawyer, Gas Turbine Publications, Inc., 1976.
4. Hafford, J. A., ORCON1: A FORTRAN Code for the Calculation of a Steam Condenser of Circular Cross Section, Oak Ridge National Laboratory, Report ORNL-TM-4248, July 1973.
5. Naval Ships Systems Command 346-0250, Technical Manual, Main Condenser and Air Ejector (DLG-6).
6. Naval Boiler and Turbine Laboratory Test T-235, DLG-6 Class Propulsion Machinery, by J. J. Foti, 15 January 1960.
7. Fujii, T., Honda, H., and Oda, K., "Condensation of Steam on a Horizontal Tube - The Influence of Oncoming Velocity and Thermal Condition at the Tube Wall," presented at the 18th National Heat Transfer Conference, San Diego, California, 4 August 1979.
8. Department of the Navy, Design Data Sheet Section DDS 4601-1, Steam Condensers, 15 October 1953.
9. Department of the Navy Military Specifications, MIL-C-15430 J (Ships), Condensers, Steam, Naval Shipboard, 19 June 1975.
10. Holman, J. P., Heat Transfer, 4th Edition, McGraw-Hill, Inc., 1976.

INITIAL DISTRIBUTION LIST

	No. of Copies
1. Defense Documentation Center Cameron Station Alexandria, Virginia 22314	2
2. Library, Code 0142 Naval Postgraduate School Monterey, California 93940	2
3. Department Chairman, Code 69 Department of Mechanical Engineering Naval Postgraduate School Monterey, California 93940	5
4. Assoc. Prof. R. H. Nunn, Code 69Nn Department of Mechanical Engineering Naval Postgraduate School Monterey, California 93940	5
5. LT Vincent J. Lynch, USN 132 Carpenter Street Dushore, Pennsylvania 18614	1
6. Mr. Walter Aerni Naval Ship Engineering Center (6145) Washington, DC 20362	1



Thesis
L97
c.1

Lynch

186533

A comparative study
of a steam surface con-
denser computer model
to field test data.

Thesis
L97
c.1

Lynch

186533

A comparative study
of a steam surface con-
denser computer model
to field test data .

thesL97

A comparative study of a steam surface c

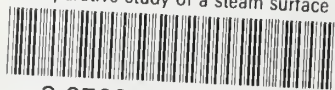

3 2768 002 12437 2

DUDLEY KNOX LIBRARY